

# Product Owner's Manual

## C842i C846i

Commercial Cycles



**PRECOR**<sup>®</sup> USA  
move beyond<sup>®</sup>



# Important Safety Instructions

When using the self-powered C846i/C842i cycle, always take basic precautions, including the following:

- Read all instructions before using the cycle. These instructions are written to protect the unit and ensure the safety of those using the cycle.
- Before beginning any fitness program, make sure all users see a physician for a complete physical examination.

*Il est conseillé de subir un examen médical complet avant d'entreprendre tout programme d'exercice. Si vous avez des étourdissements ou des faiblesses, arrêtez les exercices immédiatement.*

**DANGER** To reduce the risk of electrical shock always unplug the optional power adapter before cleaning the unit.

**WARNING** To reduce the risk of burns, fire, electric shock, or injury, take the following precautions:

- Do not allow children or those unfamiliar with its operation on or near the cycle. Do not leave children unsupervised around the unit.
- Never leave the cycle unattended with the optional power adapter plugged in. Remove the optional power adapter before cleaning the cycle, and before putting on or taking off parts.
- Assemble and operate the cycle on a solid, level surface. Locate the cycle a few feet from walls or furniture.

- Maintain the cycle in good working condition. Refer to the *Maintenance* section. Make sure that all fasteners are secure.
- If you plan to move the unit, obtain help and use a hand truck. Do not grasp any plastic parts while lifting or moving the unit. The unit is too heavy and the plastic parts will break.
- Use the cycle only for its intended purpose as described in this manual. Do not use accessory attachments that are not recommended by the manufacturer, as such attachments may cause injuries.
- Never operate the unit if it is damaged, not working properly, when it has been dropped, or has been dropped in water. Refer to *Obtaining Service*.
- Keep the optional power adapter and power cord away from heated surfaces.
- Do not operate the cycle where aerosol (spray) products are being used or where oxygen is being administered.
- Do not use outdoors.
- Do not attempt to service the cycle yourself except to follow the maintenance instructions found in this manual.
- Never drop or insert objects into any opening. Keep hands away from moving parts.
- Do not set anything on the handrails or covers. Place liquids, magazines, and books in the appropriate receptacles.

## Safety Approval

When identified with the ETL-c logo, the unit has been tested and conforms to the requirements of CAN/CSA-E-335-1/3-94, *Safety of Household and Similar Electrical Appliances*.

## Hazardous Materials and Proper Disposal

The self-powered cycle has an internal battery which contains materials that are considered hazardous to the environment. Proper disposal of the battery is required by federal law.

If you plan to dispose of your unit, contact Precor Commercial Products Customer Support for information regarding battery removal. Refer to *Obtaining Service*.

## Radio Frequency Interference (RFI)

### Federal Communications Commission, Part 15

The cycle has been tested and found to comply with

- the IEC EMC Directive (international electromagnetic compatibility certification)
- the limits for a Class A digital device, pursuant to Part 15 of the FCC Rules. These limits are designed to provide reasonable protection against harmful interference in a residential installation. The cycle generates, uses, and can radiate radio frequency energy and, if not installed and used in accordance with the owner's manual instructions, may cause harmful interference to radio communications.

**WARNING** Per FCC rules, changes or modifications not expressly approved by Precor could void the user's authority to operate the equipment.

## Canadian Department of Communications

This digital apparatus does not exceed the Class A limits for radio noise emissions from digital apparatus set out in the Radio Interference Regulations of the Canadian Department of Communications.

*Le présent appareil numérique n'émet pas de bruits radioélectriques dépassant les limites applicables aux appareils numériques de la class A prescrites dans le Règlement sur le brouillage radioélectrique édicté par le ministère des Communications du Canada.*

### **ATTENTION: Haute Tension**

**Débranchez avant de réparer**

## European Applications

This product conforms to the requirements of the European Council Directive 89/336/EEC, Electromagnetic Compatibility and has been tested to the following standards:

EN55022, Limits & Methods of Measurement of Radio Interference, Information Technology Equipment.

EN50082-1, Generic Immunity Standard for Residential, Commercial and Light Industrial Products.

This product also conforms to the requirements of the European Council Directive 73/23/EEC, Low Voltage Directive and has been tested to the following standard:

IEC 335-1, Safety of Household and similar Electrical Appliances.

## Obtaining Service

You should not attempt to service the cycle except for maintenance tasks as described in this manual. For information about product operation or service, see the Precor website at [www.precor.com](http://www.precor.com). Should you need more information regarding customer support numbers or a list of Precor authorized service centers, visit the Precor website at [www.precor.com/contact](http://www.precor.com/contact).

For future reference, write the model, serial number, and date of purchase for all your units in the space provided. The serial number is printed on a label located on the rear cover (Diagram 1).

Model #: \_\_\_\_\_ Serial #: \_\_\_\_\_

Date purchased: \_\_\_\_\_

Model #: \_\_\_\_\_ Serial #: \_\_\_\_\_

Date purchased: \_\_\_\_\_

Model #: \_\_\_\_\_ Serial #: \_\_\_\_\_

Date purchased: \_\_\_\_\_

Model #: \_\_\_\_\_ Serial #: \_\_\_\_\_

Date purchased: \_\_\_\_\_

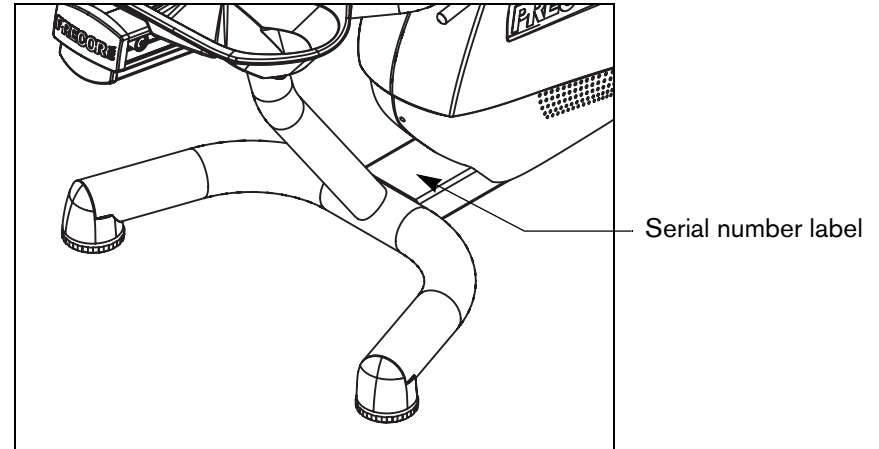

**Diagram 1: Location of serial number**

# Table of Contents

<b>Important Safety Instructions .....</b>	<b>1</b>	<b>Maintenance .....</b>	<b>19</b>
Safety Approval .....	2	Daily Inspection .....	19
Hazardous Materials and Proper Disposal .....	2	Daily Cleaning .....	19
Radio Frequency Interference (RFI) .....	2	Cleaning the Equipment .....	19
Canadian Department of Communications .....	3	Storing the Chest Strap .....	19
European Applications .....	3	Long-Term Storage .....	20
Obtaining Service .....	4	Adjusting the Seat .....	20
<b>Self-Powered Features .....</b>	<b>6</b>	Upright Cycles: Adjusting the Seat Tilt .....	21
Informational Displays Prior to Shutdown .....	6	Recumbent Cycles: Realigning the Seat .....	22
Symptoms of a Low Battery .....	7	Using the Optional Power Adapter .....	23
The Optional Power Adapter .....	7	Troubleshooting Error Codes .....	24
Replacing the Battery .....	7	Troubleshooting Heart Rate .....	24
<b>Club Features .....</b>	<b>8</b>	<b>Precor Commercial Equipment</b>	
Club Programming Tips .....	8	<b>Limited Warranty.....</b>	<b>25</b>
Choosing a Language .....	9		
Selecting a U.S. Standard or Metric Display .....	9		
Setting a Workout Time Limit .....	10		
Setting a Pause Time Limit .....	10		
Setting a Resistance Range (C846i) .....	11		
Changing the Custom Program .....	12		
Informational Displays (C842i) .....	13		
Informational Displays (C846i) .....	15		
User ID Entry with CSAFE Equipment .....	17		

# Self-Powered Features

The power source for the cycle is the user. When a person maintains a pedal speed above 20 revolutions per minute (RPM), the power that is generated allows the cycle to function properly.

Informational displays appear when the battery is low or when the user reduces the pedal speed below the minimum requirement. The display explains what to do to retain power. If the messages are ignored, the cycle begins shutdown procedures to maintain the charge of the battery. Refer to *Informational Displays Prior to Shutdown*.

An optional power adapter can be purchased and provides sustained power to the cycle. If you plan to customize your unit, the power adapter is highly recommended. To purchase the optional power adapter, check with your dealer. Refer to *Obtaining Service*.

## Informational Displays Prior to Shutdown

The cycle saves its battery charge by moving into a shutdown mode. Whenever PEDAL FASTER appears on the display, the heart rate, SmartRate® and program indicators turn off. If the user does not maintain a pedal speed of 20 RPM, then a 20-second shutdown process begins.

When 28 seconds remain, 28 dots appear in the center display. All key presses are ignored except RESET. If no one begins pedaling, a dot disappears every second as the countdown continues.

**Note:** The user can resume exercising if he or she begins pedaling before the 28-second period elapses.

**Note:** If the cycle is connected to a CSAFE master device, a slightly different scenario occurs. When ten seconds remain before the cycle shuts off, the workout session ends. RESETTING appears in the lower display while the cycle disconnects from the CSAFE master device. All key presses are ignored. pedaling has no effect on the display.

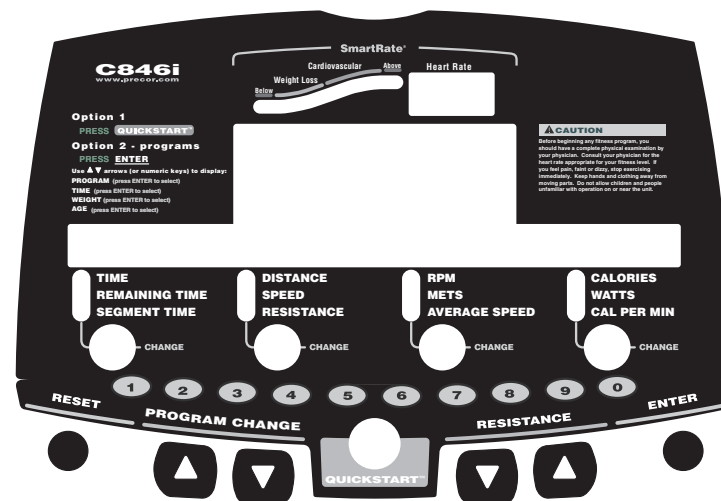

Diagram 2: C846i display



## Symptoms of a Low Battery

If no one has used the cycle for an extended period of time, the battery may need recharging.

Symptoms of a low battery include:

- A flickering or erratic display
- No workout statistics appear or accumulate
- Changes to the pedal speed are ignored

The cycle continues to function with a low battery, but user and program information is lost once the user stops pedaling.

**Note:** To maintain a constant power source, use the optional power adapter.

## The Optional Power Adapter

The display functions differently when the power adapter is connected. Because the power adapter provides a constant source of power, the user can stop pedaling during a workout and pause for brief periods without the cycle initiating shutdown procedures. When the pause time limit expires and the user has not resumed pedaling, the display returns to the Precor banner. Refer to *Setting a Pause Time Limit*. To learn how to use the power adapter, refer to *Using the Optional Power Adapter*.

## Replacing the Battery

The internal battery is built to last for a long time. However, if you feel that the battery may need replacing, check with an authorized service technician. Refer to *Obtaining Service*.

**CAUTION:** The battery stored inside the cycle C846i/C842i contains hazardous materials and must be disposed of according to Hazardous Waste Regulations. Refer to *Hazardous Materials and Proper Disposal*.

# Club Features

These next few pages provide information that lets you customize the cycle for your club. All these features remain hidden to the club patrons and can only be accessed using special key presses. Read this section if you want to:

- Change the display to a different language
- Change the display to U.S. Standard or Metric
- Set the maximum workout and pause times
- Set a cool-down time limit
- Customize a program
- View the odometer
- Display the number of hours the cycle has been in use
- View the software versions and part numbers
- Check the error log
- Display the serial number
- Connect to CSAFE equipment

## Club Programming Tips

- Electrical power must be supplied. A minimum pedal speed (20 revolutions per minute) must be maintained while programming the cycle. A constant power source is available if you use the optional power adapter. If you plan to program the cycle, purchasing the optional power adapter is highly recommended.  
**Note:** If you do not use the optional power adapter during club programming mode, and the pedal speed falls below 20 RPM, no warning is given when the cycle moves into its 30-second shutdown procedure.
- The club programming mode is accessed by pressing the RESET key at the Precor banner. The remaining key presses must occur quickly and without pause. Always start at the Precor banner.
- The function of the QUICKSTART key is disabled while in club programming mode.
- The club programs appear sequentially. Pressing the ENTER key on the C846i or the SELECT on the C842i saves the changes you make and moves you through the programs. To exit a program without saving any changes, press the RESET key.

## Choosing a Language

The cycle can display user prompts, text, and user entries in six different languages. When the cycle is shipped from the factory, it is set to display English. To change this setting, perform the following steps:

1. At the Precor banner, press the following C846i number keys in sequence and without pause:

RESET, 5, 6, 5, 1, 5, 6, 5

Numbers appear on the display as you press the associated key.

**Note:** The C842i does not have a number keypad, so each key is associated with a number. Refer to Diagram 4. To enter club programming mode and change the language, press the following sequence: RESET, SELECT, RESISTANCE ▼, SELECT, COURSE CHANGE ▲, SELECT, RESISTANCE ▼, SELECT.

At the SELECT LANGUAGE prompt, use the arrow keys to choose between ENGLISH, DEUTSCH, ESPANOL, FRANCAIS, NEDERLANDS, RUCCKIJJ (C846i only), and PORTUGUES.

**Note:** Programming prompts are not affected by language selection. The prompts in this section continue to appear in English.

2. When you are ready, press SELECT (C842i) or ENTER (C846i) to move to the next program or press RESET to return to the Precor banner.



Diagram 3: C842i display and keypad numbers

## Selecting a U.S. Standard or Metric Display

The cycle can display measurements in either METRIC or U.S. STANDARD. The default factory setting is set to display U.S. STANDARD. To change this setting, perform the following steps:

3. At the SELECT UNITS prompt, use an arrow key to select a unit of measure (U.S. STANDARD or METRIC).
4. When you are ready, press SELECT (C842i) or ENTER (C846i) to move to the next program or press RESET to return to the Precor banner.

## Setting a Workout Time Limit

You can limit how long a user can exercise on the cycle. For example, if you set the time limit to 20 minutes, users can only enter a workout time between 1 and 20 minutes.

**Note:** The automatic cool-down period is appended to the end of any time-based program, so adjust the time limit accordingly.

You can also let a user exercise indefinitely by selecting the NO LIMIT option. You will need to instruct users to select NO LIMIT (C842i) or press the number 0 (C846i) when they are prompted for a workout time.

**Note:** The REMAINING TIME (C846i) display will not appear if the NO LIMIT option is chosen.

The range of workout time available are:

<i>Cycle</i>	<i>Workout Time</i>
C842i	1 to 99 minutes
C846i	1 to 240 minutes

- At the SET MAX WORKOUT TIME prompt, use the arrow keys to display the available time limits. Choose between 1 and 240 minutes. Or, choose NO LIMIT.

**Note:** When you press and hold an arrow key, the selections increment by five, for example, 1, 5, 10, 15, and 20. When you tap an arrow key, the selections increment by one.

- When you are ready, press SELECT (C842i) or ENTER (C846i) to move to the next program or press RESET to return to the Precor banner.

## Setting a Pause Time Limit

You can limit how long a user can pause while exercising on the cycle by entering a time between 1 and 120 seconds (two minutes). For example, if you set the pause time limit to 60 seconds, the display automatically resets to the Precor banner if no pedaling or key press occurs for one minute.

**Important:** *The optional power adapter must be connected to establish a pause time limit. If the optional power adapter is not attached and the pedal speed drops below 20 revolutions per minute, the cycle begins its 30-second shutdown effectively eliminating pause mode.*

- At the SET MAX PAUSE TIME prompt, use the arrow keys to cycle through the available time limits. Choose between 1 and 120 seconds (two minutes).
- When you are ready, press SELECT (C842i) or ENTER (C846i) to move to the next program or press RESET to return to the Precor banner.

## Setting a Resistance Range (C846i)

You can set a low, medium or high range of resistance on the C846i cycle. Within each group, 25 resistance settings are available, but the chosen group affects the overall resistance range.

An example of where you might use this programming feature is physical therapy conditioning. If a user has an injury that needs low levels of resistance, you might set the resistance range to low to help ensure that the user does not induce further injury by exceeding your recommended levels of resistance. The following table provides short description of each group.

<i>Setting</i>	<i>Description</i>
HIGH	provides the full range of resistance available. If an upright cycle user chooses the high-end resistance levels, the cycle provides enough resistance to simulate sprinting or hill climbing for users wishing to stand on the upright cycle. It also provides enough resistance for elite riders that are capable of spinning at high speed with high resistance.
MEDIUM	provides approximately two thirds of the resistance that is available within the HIGH group setting. Club owners may want to select the MEDIUM range for recumbent cycles. Since users cannot stand on recumbent cycles, less resistance is needed by the average (non-elite) user. A MEDIUM range may provide more comfort. It also allows users to make easier resistance changes in the preset programs (HILL CLIMB and CROSS COUNTRY).
LOW	provides approximately one third of the resistance that is available within the HIGH group setting. The LOW range may be appropriate in special situations where poorly conditioned users are anticipated. The LOW range is not recommended for the club environment.

9. At the SET RESISTANCE RANGE prompt, use an arrow key to choose LOW, MEDIUM or HIGH.
10. When you are ready, press ENTER to save your changes and move to the next program. If you prefer to exit the program without saving your changes, press RESET.

## Changing the Custom Program

**Important:** To change the Custom Program, it is highly recommended that you use the optional power adapter. Otherwise, you will need to maintain a pedal speed above 20 revolutions per minute to keep the cycle from shutting down.

When you design a custom program, you are preprogramming the resistance for each column in the program profile.

11. A blinking column appears in the display. Use the COURSE CHANGE ▼▲ keys to change the height of the column.
12. When the column height is set, use RESISTANCE ▲ to move to the next column. You can use RESISTANCE ▼ to move back and change earlier columns as needed.
13. Continue setting resistance level for each column in the profile.

14. When you are ready, press ENTER to save the program and return to the Precor banner.

**Note:** If you prefer to exit the program without saving changes to the custom profile, press RESET.

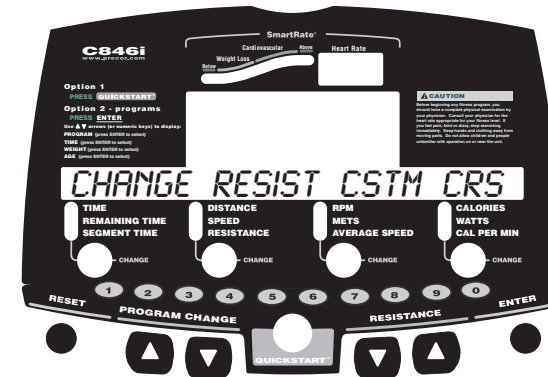

**Diagram 4: Modify the Custom program**

## Informational Displays (C842i)

The C842i cycle provides information about its use (odometer and hour meter), as well as software version, and error log. In general, you would only access this information if directed to do so by Precor Customer Support.

These instructions guide you through all four informational displays.

### Viewing the Odometer

1. At the Precor banner, press the following keys in sequence and without pause:  
RESET, RESISTANCE ▼, SELECT  
Numbers appear on the display as you press the associated key.  
REVOLUTIONS appears on the display followed by the odometer value (number of total revolutions).
2. When you are ready, press SELECT to move to the next display (hour meter).

### Viewing the Hour Meter

HOURS appears followed by the number of hours that the unit has been in use. The cycle tracks the elapsed minutes, but the value that appears is truncated to the nearest full hour.

3. When you are ready, press SELECT to move to the next display (software version).

### Viewing the Software Version and Part Numbers

UPPER SW scrolls across the display followed by the upper board application software part number and version (for example, 48181-350).

4. To see the upper boot and lower boot application software version, press the SELECT key. If needed, you can move through all three—upper board, upper boot, and lower board—using the SELECT key.
5. Write the numbers below. You will need these numbers when you call Customer Support with display-related questions. This information will help rule out any software-related problems:  
Upper Software P/N: \_\_\_\_\_  
Upper Boot Software P/N: \_\_\_\_\_  
Lower Software P/N: \_\_\_\_\_
6. When you are ready, press RESET to move to the next display (error log).

## Viewing the Error Log

The first error log entry scrolls across the display. Up to ten error codes can be retrieved. If there are no errors in the log, you will see NO ERRORS displayed.

7. To view any additional error codes in the error log, use the arrow keys. Each error code specifies when it occurred, listing the odometer and hour meter values. Refer to Diagram 5.

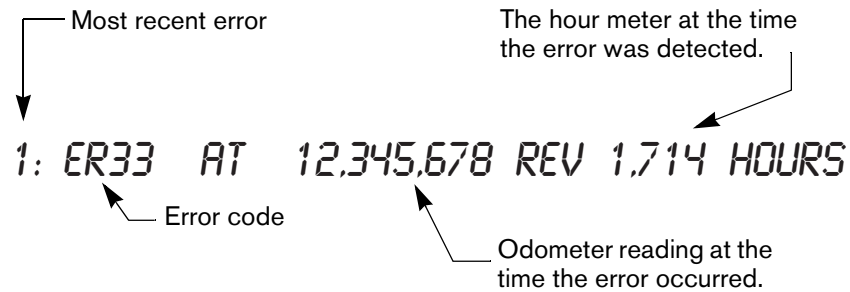

**Diagram 5: Error log**

8. Copy the error code information to paper so you can provide it to Customer Support if needed. Be sure to copy it exactly as shown.

9. When you no longer need the information in the error log, press QUICKSTART for at least four seconds to delete the error log. Continue to maintain light pressure on the key until the message OK appears. When the key is released, NO ERRORS appears in the display, which indicates the error log has been deleted.

**Important:** You cannot retrieve the error log once you have deleted it. You may want to resolve any issues you are experiencing with the cycle before clearing the error log.

10. When you are ready, press SELECT or RESET to move to the next display.



## Informational Displays (C846i)

The C846i cycle provides information about its use (odometer and hour meter), as well as software version, error log, and serial number. In general, you would only access this information if directed to do so by Precor Customer Support.

These instructions guide you through all five informational displays. Pressing the ENTER key moves you through the displays. To exit, press the RESET key at any time.

### Viewing the Odometer

1. At the Precor banner, press the following keys in sequence and without pause:

RESET, 6, 5

Numbers appear on the display as you press the associated key.

The odometer value (the total revolutions) appears on the display followed by the word REVOLUTIONS.

2. When you are ready, press ENTER to move to the next display (hour meter).

### Viewing the Hour Meter

HOUR METER appears followed by the number of hours that the unit has been in use. The cycle tracks the elapsed minutes, but the value that appears is truncated to the nearest full hour.

3. When you are ready, press ENTER to move to the next display (software version).

## Viewing the Software Version and Part Numbers

SOFTWARE VERSION appears for two seconds. UPPER APP then appears followed by the upper board application software part number and version (for example, 48181-350).

4. To see the upper boot and lower boot application software version, use the arrow keys. If needed, you can move through all three—upper board, upper boot, and lower board—using the arrow keys.
5. Write the numbers below. You will need these numbers when you call Customer Support with display-related questions. This information will help rule out any software-related problems:  
Upper Application P/N: \_\_\_\_\_  
Upper Boot Software P/N: \_\_\_\_\_  
Lower Application P/N: \_\_\_\_\_
6. When you are ready, press ENTER to move to the next display (error log).

## Viewing the Error Log

ERROR LOG appears on the display followed by the first entry in the error log if there are any errors. Up to ten error codes can be retrieved.

If there are no errors in the log, you will see NO MORE ERRORS displayed.

7. To view any additional error codes in the error log, use the arrow keys. Each error code specifies when it occurred, listing the odometer and hour meter values. Refer to Diagram 6.

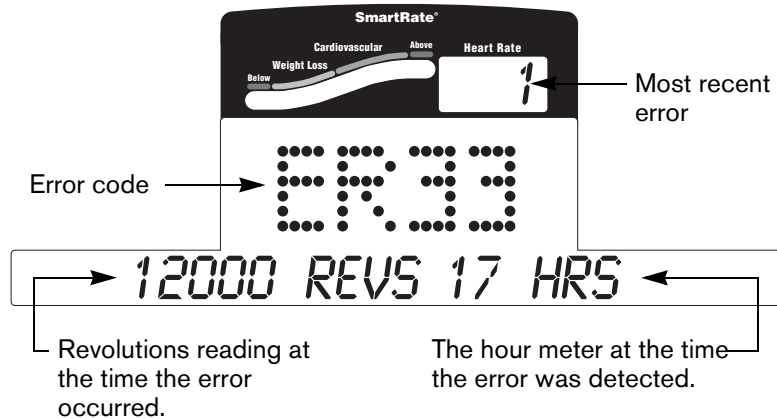

**Diagram 6: Error log**

8. Copy the error code information to paper so you can provide it to Customer Support if needed. Be sure to copy it exactly as shown.
9. When you no longer need the information in the error log, press QUICKSTART for at least four seconds to delete the error log. Continue to maintain light pressure on the key until the message CLEARED appears. When the key is released, 1 appears in the Heart Rate display and dashes appear in the error code display, which indicates the error log has been deleted.

**Important:** You cannot retrieve the error log once you have deleted it. You may want to resolve any issues you are experiencing with the cycle before clearing the error log.

10. When you are ready, press SELECT (C842i) or ENTER (C846i) to move to the next display (serial number).

## Displaying the Serial Number

SERIAL NUMBER appears on the display followed by the 13-digit serial number. The serial number is helpful when you contact Customer Support.

**Note:** If no serial number has been entered, then NO SERIAL NUMBER appears. Use the serial number found on a label on the rear cover (Diagram 1).

11. If you have not already done so, write the serial number onto the Warranty Registration card. You can also register online at [www.precor.com](http://www.precor.com).
12. When you are ready, press ENTER to return to the Precor banner.

## User ID Entry with CSAFE Equipment

The C846i cycle is fully compatible with CSAFE protocols. When the unit is connected to a CSAFE master device and the user maintains a pedal speed above 20 revolutions per minute (RPM), the user is prompted for a user ID.

**Note:** If the optional power adapter is being used, then no pedaling is necessary for user ID entry.

The user ID is displayed as five zeros. The left most zero blinks indicating you starting point. The following table describes key functions while in CSAFE mode.

<i>Keypad</i>	<i>Description</i>
PROGRAM CHANGE ▲ or ▼	moves the blinking LED from column to column
RESISTANCE ▼ or ▲	changes the number value in the in the selected column
Number keypad	use the number keys to enter a user ID. The number that is pressed appears in the display and the next column begins to blink. When all five numbers are in place, the user must press ENTER to submit the user ID.
ENTER	submits the user ID. <b>Note:</b> User ID entry is bypassed when the user enter five zeros. No workout statistics are recorded.
RESET	resets the display to the Precor banner.

A message appears on the display and indicates when the user ID is accepted by the CSAFE master device. Then, the program prompt appears. The user has the option to choose QUICKSTART or select a program and begin exercising.

**Note:** If the user's pedal speed drops below 20 RPM and the optional power adapter is not installed, a prompt PEDAL FASTER appears. If the pedal speed remains below the 20 RPM threshold for the next twenty seconds, the CSAFE connection is terminated. The word RESETTING may appear on the display while the cycle disconnects from the CSAFE device.

To review information about CSAFE specifications, visit the website at: [www.fitlinx.com/csafe](http://www.fitlinx.com/csafe)

If you have questions or need technical support, refer to *Obtaining Service*.

# Maintenance

It is important to perform the minor maintenance tasks described in this section. Failure to maintain the cycle as described here could void the Precor Limited Warranty.

**DANGER** To reduce the risk of electrical shock, always unplug the unit from its optional power adapter before performing any maintenance tasks.

## Daily Inspection

Look and listen for slipping belts, loose fasteners, unusual noises, and any other indications that the equipment may be in need of service. If you notice any of these, obtain service.

*Important: If you determine that the cycle needs service, move it away from the usual exercising area. Place an "out of service" sign on it and make sure all users know that the cycle needs service.*

To order parts or to contact a Precor authorized service provider in your area, refer to *Obtaining Service*.

## Daily Cleaning

Precor recommends the cycle be cleaned before and after each workout. Use a damp, soft cloth to clean all exposed surfaces.

## Cleaning the Equipment

Most of the working mechanisms are protected inside the covers. However, for efficient operation, the cycle relies on low friction. To keep the friction low, the cycle pedals and internal mechanisms must be as clean as possible.

Frequently vacuum the floor underneath the unit to prevent the accumulation of dust and dirt, which can affect the smooth operation of the unit. Clean the grooves on the pedals using a soft nylon scrub brush.

**CAUTION: Do not use any acidic cleaners. Doing so will weaken the paint or powder coatings and void the Precor Limited Warranty. Never pour water or spray liquids on any part of the cycle. Allow the cycle to dry completely before using.**

## Storing the Chest Strap

Store the chest strap where dust and dirt cannot accumulate on it, such as a closet or drawer. Be sure to keep the chest strap protected from extremes in temperature. Do not store it in an area that may be exposed to temperatures below 32° F (0° C).

To clean the chest strap, use a sponge or soft cloth dampened in mild soap and water. Dry the surface thoroughly with a clean towel.

## Long-Term Storage

When the cycle is not in use for any length of time, ensure that the optional power adapter is unplugged from its power source and is positioned so that it and the power cord will not become damaged or interfere with people or other equipment.

## Adjusting the Seat

To avoid knee strain, it is important that you inform your patrons about positioning the seat properly.

To check for proper seat position, be sure users take the following steps:

1. Sit on the seat.
2. Place each foot on a pedal (inside the pedal straps).
3. Observe the position of each leg. The extended leg should be slightly bent at the knee in a 10 to 15 degree angle.

If seat adjustment is needed, refer to the following instructions.

## Upright Seat Adjustment

1. Dismount and hold the post underneath the seat with one hand while you pull out the seat post adjustment pin (pop pin) with the other hand. Refer to Diagram 7.
2. Slide the seat post up or down into the desired position and then release the seat post adjustment pin.
3. Before sitting on the cycle, press down firmly on the seat to make sure it does not slip. Check that the pop pin is secure inside the seat post.

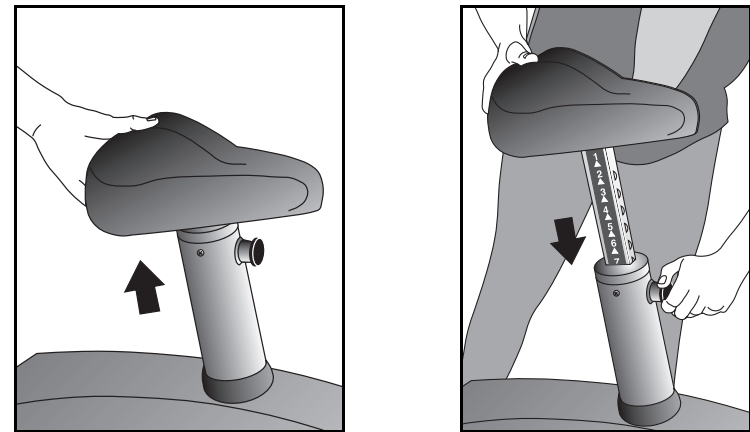

**Diagram 7: Adjusting the seat on the C842i Upright Cycle**

## Recumbent Seat Adjustment

1. Sit on the seat with your feet in the pedals.
2. Pull the seat adjustment handle up while you bend your knees and slide the seat forward or backward along the seat rail. Refer to Diagram 8.

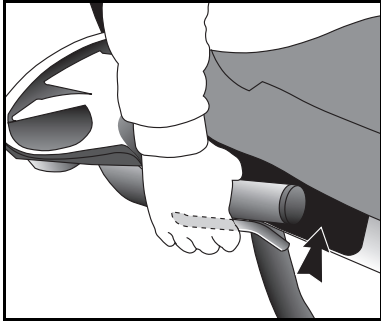

**Diagram 8: Adjusting the seat on the C842i Recumbent Cycle**

3. Align the seat with one of the marks on the seat rail and release the handle.
4. Try to slide the seat along the seat rail. Make sure the seat does not move before beginning your exercise session.

## Upright Cycles: Adjusting the Seat Tilt

To adjust the seat tilt on upright cycles, take the following steps.

1. Use a 11/16-inch (17 mm) box-end wrench or crescent wrench to loosen the nut beneath the seat. Refer to Diagram 9.

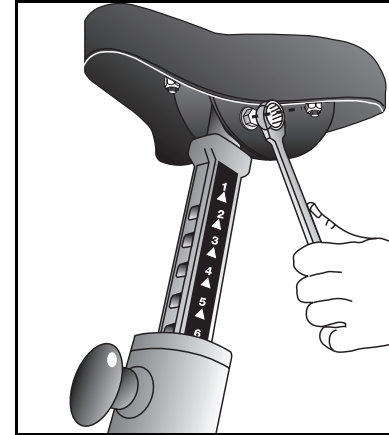

**Diagram 9: Loosen nut to adjust seat tilt**

2. Adjust the seat tilt (forward or backward) as shown in Diagram 10.

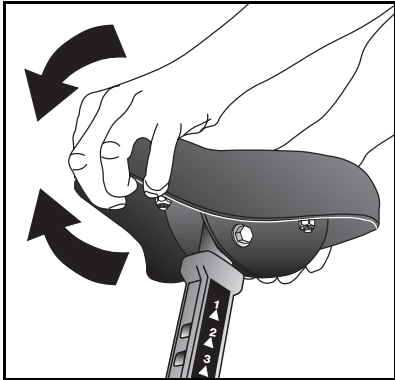

**Diagram 10: Tilt the seat forward or backward**

3. Wrench tighten the nut
4. Apply pressure to the seat and make sure that it does not move. Readjust and retighten the nut, if needed.

## Recumbent Cycles: Realigning the Seat

If the seat rocks side-to-side, you need to realign the center wheel underneath the seat. Adjustment screws are located on the left side of the seat rail.

To remove seat wobble (side to side movement), take the following steps.

1. Obtain a  $\frac{3}{16}$ -inch and  $\frac{5}{16}$ -inch hex key.

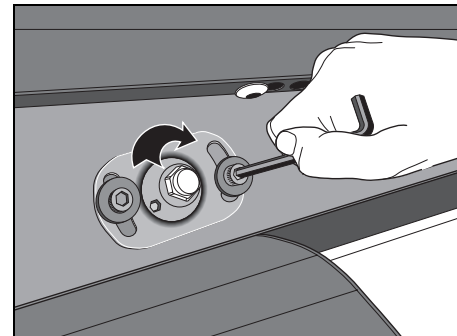

**Diagram 11: Loosen the two adjustment screws**

2. Use the  $\frac{3}{16}$ -inch hex key to loosen the two adjustment screws as shown in Diagram 11.



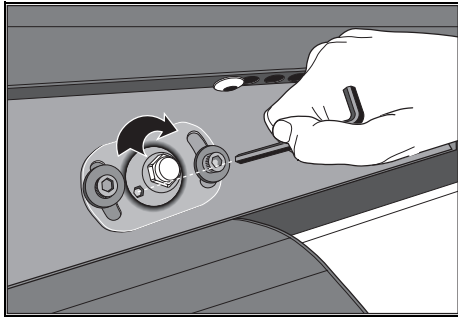

**Diagram 12: Wheel lock adjustment**

3. Use the  $\frac{5}{16}$ -inch hex key to turn the wheel lock adjustment key clockwise  $\frac{1}{4}$  turn. Refer to Diagram 12. This process realigns the center wheel inside the top rail. Leave the  $\frac{5}{16}$ -inch hex key in place while you tighten the adjustment screws with the  $\frac{3}{16}$ -inch hex key.
4. Remove the hex keys and check that the seat no longer rocks side-to-side. If the rocking movement continues, you need to repeat steps 2 and 3.

## Using the Optional Power Adapter

If you purchase the optional power adapter, you must also purchase the internal cable kit. The kit supplies the cable, bracket, and fasteners that connect the power adapter to the lower electronics board.

**CAUTION:** The internal cable kit must be installed by authorized service personnel. Do not attempt installation on your own as you could void the Precor Limited Warranty. For more information, refer to *Obtaining Service*.

Once the internal cable kit is installed, you can plug the optional power adapter into the unit as shown in Diagram 13. Plug the opposite end into the appropriate power source for your unit (110/120v or 220/240v).

**Important:** When the optional power adapter is in use, ensure that the power cord does not create a safety hazard. Keep it out of the way of traffic and moving parts. If the power cord or power adapter is damaged it should be replaced.

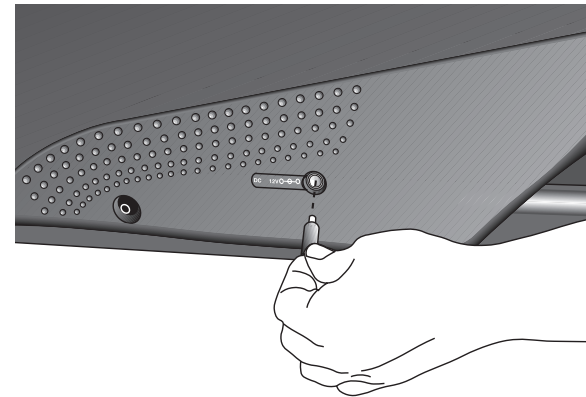

**Diagram 13: Optional power adapter receptacle**

## Troubleshooting Error Codes

If any error codes appear in the display, call an authorized service person for assistance. Refer to *Obtaining Service*.

## Troubleshooting Heart Rate

Table 1 may help you understand and troubleshoot erratic heart rate readings.

**Important:** A heart rate can only be detected when the Precor heart rate receiver is properly installed in the display and the user maintains a minimum of 20 RPM. A user must also wear the chest strap on the C842i or grasp both touch-sensitive handlebar grips on the C846i.

**Table 1. Erratic heart rate readings**

<i>What appears on the display</i>	<i>Cause</i>	<i>What to Do</i>
Nothing	The heart rate receiver is not installed or it has been disconnected.	Call Customer Support. Refer to <i>Obtaining Service</i> .
---	A signal is being detected through the chest strap, but a valid heart rate is not yet established.	Be sure that the chest strap is moist, centered, and in direct contact with the user's skin. Wait a few moments to see if the user's heart rate appears.

<i>What appears on the display</i>	<i>Cause</i>	<i>What to Do</i>
Pulsing Hr	A signal is being detected through the touch-sensitive handlebar grips, but a valid heart rate is not yet established.	Ask the user to grasp both handlebar grips (C846i only) until his or her heart rate appears.

**Note:** To conduct electrical impulses from a user's heart, both touch-sensitive handlebar grips (C846i) must be grasped firmly for five to ten seconds. Usually, the concentration of salts in a person's perspiration provides enough conductivity to transmit a signal to the receiver in the display console. However, because of body chemistry or erratic heartbeats, some people cannot use the touch-sensitive heart rate feature. A chest strap may provide better results.

# Precor Commercial Equipment Limited Warranty

PLEASE READ THESE WARRANTY TERMS AND CONDITIONS CAREFULLY BEFORE USING YOUR PRECOR INCORPORATED PRODUCT. BY USING THE EQUIPMENT, YOU ARE CONSENTING TO BE BOUND BY THE FOLLOWING WARRANTY TERMS AND CONDITIONS.

## Limited Warranty.

Precor Incorporated warrants all new Precor products to be free from defects in materials and manufacture for the warranty periods set forth below. The warranty periods commence on the invoice date of the original purchase. This warranty applies only against defects discovered within the warranty period and extends only to the original purchaser of the product. Parts repaired or replaced under the terms of this warranty will be warranted for the remainder of the original warranty period only. To claim under this warranty, the buyer must notify Precor or your authorized Precor dealer within 30 days after the date of discovery of any nonconformity and make the affected product available for inspection by Precor or its service representative. Precor's obligations under this warranty are limited as set forth below.

## Warranty Periods and Coverage.

### Commercial Cardiovascular Products, also known as C-Series Products, (excluding StretchTrainer, Strength Products).

- Seven years frame, five years touch sensor display housing, two years parts, one year labor.
- For treadmills, five years motor fan, three years drive motor.
- For self-powered ellipticals and bikes, one year battery.
- For InSite, one year parts and labor.
- Labor coverage for options as defined below.

### StretchTrainer

Five years frame, two years parts, 90 days upholstery, no labor.

### Strength Products (S3.45 and S3.25 only)

Ten years frame; three years bearings, guide rods, cams, pulleys; one year belts, cables, hand grips, miscellaneous parts; 90 days upholstery; no labor.

## Options / Accessories / Battery-powered or Self-Operated Devices

Many options or accessories have components that are connected internally or mounted inside the electronic console. The following guidelines determine the warranty for these components. If the internal components are installed by the factory or by an authorized dealer as part of the original sale and delivery, they have a warranty that is identical to the warranty of the equipment in which they are connected or mounted. If the internal components are not installed by the factory or by an authorized dealer as part of the original sale and delivery, they have a 90 days parts and labor limited warranty. All components that are not internally connected have a 90 days parts only limited warranty. Satisfactory proof of purchase is required in all cases.

## Conditions and Restrictions.

**This warranty is valid only in accordance with the conditions set forth below:**

1. The warranty applies to the Precor product only while
  - a. it remains in the possession of the original purchaser and proof of purchase is demonstrated,
  - b. it has not been subjected to accident, misuse, abuse, improper service, or non-Precor modification.
  - c. claims are made within the warranty period.
2. Certain products are warranted for standard commercial use only (defined as use in non-fee paying clubs or facilities and less than 6 hours daily use. Unapproved use voids the warranty. Current standard commercial products include C936i, C932i, EFX524i, EFX534i.).
3. This warranty does not cover damage or equipment failure caused by electrical wiring not in compliance with electrical codes or Precor owner's manual specifications, or failure to provide reasonable and necessary maintenance as outlined in the owner's manual.
4. Except in Canada, Precor does not pay labor outside the United States.
5. Warranties outside the United States and Canada may vary. Please contact your local Dealer for details.

**This Limited Warranty shall not apply to:**

1. Software (PROM) version upgrades.
2. Normal wear and tear, consumables and cosmetic items, including, but not limited to the following: grips, seats, and labels.
3. Repairs performed on Precor equipment missing a serial number or with a serial tag that has been altered or defaced.
4. Service calls to correct installation of the equipment or instruct owners on how to use the equipment.
5. Pickup and delivery involved with repairs.
6. Any labor costs incurred beyond the applicable labor warranty period.

**Disclaimer and Release.**

The warranties provided herein are the exclusive warranties given by Precor and supersede any prior, contrary or additional representations, whether oral or written. ANY IMPLIED WARRANTIES, INCLUDING THE WARRANTY OF MERCHANTABILITY OR FITNESS FOR A PARTICULAR PURPOSE THAT APPLY TO ANY PARTS DESCRIBED ABOVE ARE LIMITED IN DURATION TO THE PERIODS OF EXPRESS WARRANTIES GIVEN ABOVE FOR THOSE SAME PARTS. PRECOR HEREBY DISCLAIMS AND EXCLUDES THOSE WARRANTIES THEREAFTER. Some States do not allow limitations on how long an implied warranty lasts, so the above limitation may not apply to you. PRECOR ALSO HEREBY DISCLAIMS AND EXCLUDES ALL OTHER OBLIGATIONS OR LIABILITIES, EXPRESS OR IMPLIED, ARISING BY LAW OR OTHERWISE, WITH RESPECT TO ANY NONCONFORMANCE OR DEFECT IN ANY PRODUCT, INCLUDING BUT NOT LIMITED TO: (A) ANY OBLIGATION, LIABILITY, RIGHT, CLAIM OR REMEDY IN TORT, WHETHER OR NOT ARISING FROM THE NEGLIGENCE OF PRECOR OR ITS SUPPLIERS (WHETHER ACTIVE, PASSIVE OR IMPUTED); AND (B) ANY OBLIGATION, LIABILITY, RIGHT, CLAIM OR REMEDY FOR LOSS OF OR DAMAGE TO ANY EQUIPMENT. This disclaimer and release shall apply even if the express warranty set forth above fails of its essential purpose.

**Exclusive Remedies.**

For any product described above that fails to conform to its warranty, Precor will provide, at their option, one of the following: (1) repair; (2) replacement; or (3) refund of the purchase price. Precor Limited Warranty service may be obtained by contacting the authorized dealer from whom you purchased the item. Precor compensates Servicicers for warranty trips within their normal service area to repair commercial equipment at the customer's location. You may be charged a trip charge outside the service area. THESE SHALL BE THE SOLE AND EXCLUSIVE REMEDIES OF THE BUYER FOR ANY BREACH OF WARRANTY.

**EXCLUSION OF CONSEQUENTIAL AND INCIDENTAL DAMAGES.**

PRECOR AND/OR ITS SUPPLIERS SHALL HAVE NO OBLIGATION OR LIABILITY, WHETHER ARISING IN CONTRACT (INCLUDING WARRANTY), TORT (INCLUDING ACTIVE, PASSIVE, OR IMPUTED NEGLIGENCE AND STRICT LIABILITY), OR OTHERWISE, FOR DAMAGE TO THE EQUIPMENT, PROPERTY DAMAGE, LOSS OF USE, REVENUE OR PROFIT, COST OF CAPITAL, COST OF SUBSTITUTE EQUIPMENT, ADDITIONAL COSTS INCURRED BY BUYER (BY WAY OF CORRECTION OR OTHERWISE) OR ANY OTHER INCIDENTAL, SPECIAL, INDIRECT, OR CONSEQUENTIAL DAMAGES, WHETHER RESULTING FROM NONDELIVERY OR FROM THE USE, MISUSE OR INABILITY TO USE THE PRODUCT. This exclusion applies even if the above warranty fails of its essential purposes and regardless of whether such damages are sought for breach of warranty, breach of contract, negligence, or strict liability in tort or under any other legal theory. Some states do not allow the exclusion or limitation of incidental or consequential damages, so the above limitation may not apply to you. This warranty gives you specific legal rights, and you may also have other rights, which vary from state to state.

**Complete this portion and keep for your records.**

Purchased From: \_\_\_\_\_  
(Dealer or store name)

Phone Number: \_\_\_\_\_  
(Dealer or store telephone number)

Product/Model: \_\_\_\_\_  
(For example: EFX534i or C966i)

Serial Number: \_\_\_\_\_  
(The serial number is found on the shipping container.)

Effective 01 December, 2004  
P/N 36286-111

**Thank You and Welcome to Precor**



We are confident that you will be pleased with your purchase and that your new Precor equipment will help satisfy your customers' fitness needs, while helping you meet your business goals.

To allow us to serve you better, please take a few moments to complete and return your warranty registration.

**YOU MAY ALSO REGISTER ONLINE AT**

**[www.precor.com/warranty](http://www.precor.com/warranty)**

If you have questions or need additional information, contact your local dealer or call Precor Commercial Products Customer Support at 888-665-4404.

Fold along dotted line and tape closed before mailing.

COMM.

Woodinville, WA 98072-4002

PO Box 7202

20031 142nd Avenue NE

Precor Incorporated



PLACE  
STAMP  
HERE

## TELL US ABOUT YOUR NEW PRECOR PRODUCTS

Date of Purchase:

Month \_\_\_\_\_ Day \_\_\_\_\_ Year \_\_\_\_\_

Purchased from (Dealer name):

\_\_\_\_\_

Product Serial Number(s):

\_\_\_\_\_

Please indicate the type and number of products purchased:

- #: \_\_\_\_\_ Elliptical Fitness CrossTrainer (EFX®)  
 #: \_\_\_\_\_ Treadmill       #: \_\_\_\_\_ Stair Climber  
 #: \_\_\_\_\_ Cycle       #: \_\_\_\_\_ Strength Station

The serial number is located on the shipping box and on the product.

\_\_\_\_\_

Add additional sheets of paper or register online at [www.precor.com/warranty](http://www.precor.com/warranty)

## TELL US ABOUT YOUR FACILITY

\_\_\_\_\_

Name of Facility

\_\_\_\_\_

Contact Person — First Name

Last Name

Facility Address

\_\_\_\_\_

Apt./Suite

City

State

Zip Code

Area Code      Facility Telephone Number

Your Business Email Address

\_\_\_\_\_

How many members do you have?

- Less than 100       100 – 500       500 – 1000       1000 – 2000       2001 +

What percentage of floor space do you allocate for cardio equipment?

- 0% to 20%       20% to 40%       40% to 60%       60% to 80%       80% to 100%

What type of equipment makes up your cardio offering (check all that apply)?

- Treadmills       Ellipticals       Cycles       Stair Climbers       Rowing Machines       Other

What other brands of cardio equipment do you currently offer (check all that apply):

- Life Fitness       True       Cybex       StarTrac       Other

What other Precor equipment do you currently offer (check all that apply):

## TELL US ABOUT YOUR PURCHASE

- EFX       Cycle       StretchTrainer™  
 Treadmill       Stair Climber       Strength Machine       Other

Which best describes this purchase (check all that apply):

- First Precor product       Replaces a Precor product of the same type  
 brand owned       Replaces same type of product – different brand  
 owned       Enhancement to equipment already owned

How did you FIRST become aware of this product (choose only one):

Please detach and mail in the warranty registration within ten days of purchase.



## C842i/C846i Commercial Cycles

### Product Specifications

	C842i Upright	C842i Recumbent	C846i Upright	C846i Recumbent
Length:	50 in (127 cm)	57 in (145 cm)	54 in (137 cm)	56 in (142 cm)
Width	24 in (61 cm)	24 in (61 cm)	24 in (62 cm) <sup>1</sup>	24 in (62 cm)
Height	60 in (152 cm)	48 in (122 cm)	53 in (135 cm)	48 in (122 cm)
Weight	130 lb (59 kg)	160 lb (73 kg)	127 lb (57 kg)	152 lb (68 kg)
Shipping weight	190 lb (86 kg)	220 lb (100 kg)	142 lb (64 kg)	167 lb (75 kg)
Power	Self-powered	Self-powered	Self-powered	Self-powered
Resistance levels	1-20	1-20	1-25	1-25
Frame	Powder-coated steel	Powder-coated steel	Powder-coated steel	Powder-coated steel
Regulatory Approvals	FCC, ETL, CE	FCC, ETL, CE	FCC, ETL, CE	FCC, ETL, CE

### Product Features

	C842i	C846i
CSAFE Compatible		✓
Heart Rate Telemetry	✓	✓
QuickStart™	✓	✓
SmartRate®	✓	✓
Touch Heart Rate		✓
Touch Sensitive Display		✓



Precor Incorporated  
20031 142nd Ave NE  
P.O. Box 7202  
Woodinville, WA USA 98072-4002

Precor, C, CrossRamp, EFX, M, Move Beyond, and SmartRate are registered trademarks of Precor Incorporated. Crosstrainer, QuickStart, and StretchTrainer are trademarks of Precor Incorporated.  
Copyright 2005 Precor Incorporated.  
Specifications subject to change without notice.  
[www.precor.com](http://www.precor.com)

#### NOTICE:

Precor is widely recognized for its innovative, award winning designs of exercise equipment. Precor aggressively seeks U.S. and foreign patents for both the mechanical construction and the visual aspects of its product design. Any party contemplating the use of Precor's product designs is hereby forewarned that Precor considers the unauthorized appropriation of its proprietary rights to be a very serious matter. Precor will vigorously pursue all unauthorized appropriation of its proprietary rights.

### Programs

	C842i	C846i
Manual	✓	✓
Calorie Goal		✓
Cross Country	✓	✓
Distance Goal		✓
Fitness Test*		✓
Heart Rate Control*	✓	✓
Hill Climb	✓	✓
Interval 1	✓	✓
Interval 2		✓
Interval 3		✓
Random		✓
Resistance Custom		✓
Watts Control		✓
Weight Loss	✓	✓

### Display Readouts

	C842i	C846i
Calories	✓	✓
Calories Per Minute		✓
Distance	✓	✓
Heart Rate*	✓	✓
METS		✓
Profile	✓	✓
Remaining Time		✓
Resistance Levels	1-20	1-25
RPM	✓	✓
Segment Time		✓
SmartRate*	✓	✓
Speed	✓	✓
Time	✓	✓
Watts	✓	✓
Workout Summary	✓	✓

\* Use of a chest strap or the touch-sensitive handrail grips is required.



C842i/C846i POM 48816-101, en  
Warranty # 36287-111, en  
Registration Card# 45622-101, en  
15 July 2005



User's Reference Manual

# C846i

Commercial Cycle



**C846i Recumbent**

**PRECOR**<sup>®</sup><sub>USA</sub>  
move beyond<sup>®</sup>



## Important Safety Instructions

When using the C846i cycle, always take basic precautions, including the following:

- Read all instructions before using the cycle. These instructions are written to ensure your safety and to protect the unit.
- Before beginning any fitness program, see your physician for a complete physical examination.

*Il est conseillé de subir un examen médical complet avant d'entreprendre tout programme d'exercice. Si vous avez des étourdissements ou des faiblesses, arrêtez les exercices immédiatement.*

- Do not allow children or those unfamiliar with its operation on or near the cycle. Do not leave children unsupervised around the unit.
- Wear proper exercise clothing and shoes for your workout and avoid loose clothing. Do not wear shoes with heels or leather soles. Tie long hair back.
- Use care when getting on or off the cycle. Use the handlebar for stability.

- Keep your body and head facing forward. Never attempt to turn around on the cycle.
- Do not rock the unit. Do not stand on the handlebars, display console, or plastic covers.
- Never place your hands or feet in the path of the pedals because injury may occur to you or damage may occur to the equipment.
- Do not overexert yourself or work to exhaustion. If you feel any pain or abnormal symptoms, stop your workout immediately and consult your physician.

## Obtaining Service

The club owner or manager can help you with most questions regarding the cycle. For additional information about product operation or exercise routines, see the Precor website at [www.precor.com](http://www.precor.com).

# Table of Contents

<b>Important Safety Instructions</b> .....	<b>1</b>	<b>Workout Options</b> .....	<b>13</b>
Obtaining Service .....	1	Choosing QUICKSTART .....	14
<b>Cycle Features</b> .....	<b>3</b>	Selecting a Program .....	14
Self-Powered Features .....	3	Changing the Program during an Exercise Session .....	15
Adjusting the Seat .....	3	Cooling Down After a Workout .....	16
Using the Handlebars .....	4	Pausing During a Workout or the	
Storing Workout Statistics .....	4	Cool-Down Period .....	17
<b>Heart Rate Features</b> .....	<b>5</b>	Ending a Workout .....	17
Guidelines .....	5	<b>Programs</b> .....	<b>18</b>
Using the Heart Rate		Choosing a Program .....	18
Touch-Sensitive Grips .....	6	Program Tips .....	19
Using SmartRate .....	7	1 Manual Program .....	19
Exercise to Your Target Heart Rate .....	8	2 Cross Country Program .....	20
Heart Rate Analysis .....	8	3 Hill Program .....	20
<b>Display Console</b> .....	<b>9</b>	4 Random Program .....	21
More Information about the Center Display .....	10	Interval Programs 5, 6, and 7 .....	21
More Information about the Lower Display .....	10	8 Watts Control Program .....	22
Keypad .....	12	9 Heart Rate Control Program .....	22
		10 Weight Loss Program .....	23
		11 Custom Resistance Program .....	24
		12 Distance Program .....	25
		13 Calories Program .....	25
		14 Fitness Test .....	26

# Cycle Features

The cycle is equipped with certain items that, when used properly, help sustain an enjoyable workout. These items include:

- Self-powered features
- Seat Adjustments
- Handlebars
- Heart rate grips on the handlebars
- Workout statistics storage

**Important:** Before exercising, review the Important Safety Instructions found at the beginning of this manual.

## Self-Powered Features

The cycle does not require an electrical power connection. It has an internal battery that is recharged every time you exercise for a reasonable period of time. A pedaling speed above 20 revolutions per minute (RPM) must be maintained for several seconds before the Precor banner appears on the display. Once the banner appears, you can press QUICKSTART or ENTER to begin exercising. For more information, refer to *Workout Options*.

## Adjusting the Seat

Information on how to adjust the seat and seat tilt is found in the *Product Owner's Manual*. Refer to that manual or ask club personnel to show you the proper techniques.

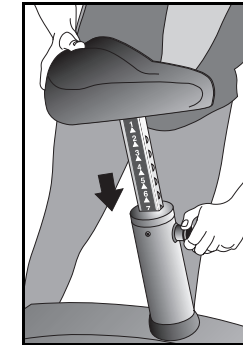
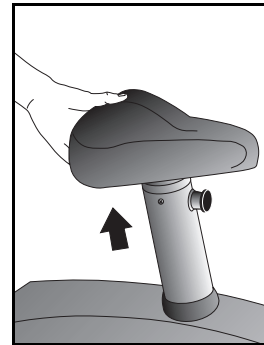

**Diagram 1: Adjusting the seat on the C846i Upright Cycle**

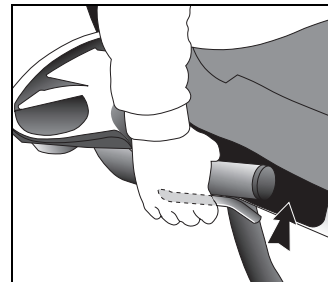

**Diagram 2: Adjusting the seat on the C846i Recumbent Cycle**

## Using the Handlebars

To maintain your balance on the C846i upright cycle, always grasp a handlebar when you step on or off the cycle, and when you use the keypad. On the recumbent cycle, use the handlebar to maintain your comfort.

To learn more about the touch-sensitive handlebar grips, refer to *Heart Rate Features*.

## Storing Workout Statistics

Many clubs connect the cycle to a computer so you can easily retrieve your workout statistics and determine how well you are meeting your fitness goals. If you are interested in maintaining workout statistic information, ask the club personnel to create a user account and a user ID for you.

A user ID entry is required to store your workout statistics. If the display is blank, begin pedaling. Maintain a pedaling speed above 20 revolutions per minute. If five zeros appear on the display, the cycle is connected to a computer. If the Precor banner appears, the cycle is not connected to a computer.

**Note:** When the optional power adapter is attached and the cycle is connected to a computer, five zeros appear on the display and remain until a user ID is entered.

To access the cycle workout options, take the following steps:

1. As the leftmost zero blinks, use the number keypad to specify your 5-digit user ID. If you make a mistake, use the ▼ arrow key to move back and reenter the correct number.

**Note:** To bypass the user ID entry, press ENTER or QUICKSTART while all five zeros appear in the user ID field. No workout statistics are added to your file.

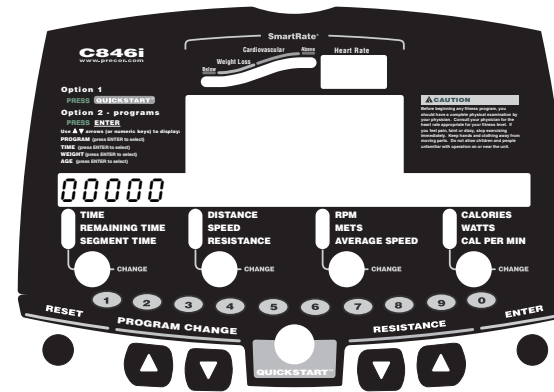

2. When your user ID is shown, press ENTER.

A message appears and indicates when the user ID is accepted by the computer. Then, a program name appears.

3. To select a different program, press an arrow key. Refer to *Workout Options*.

# Heart Rate Features

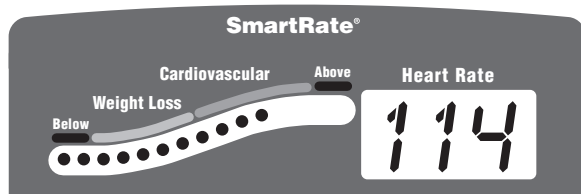

Heart rate and SmartRate® features are available when you wear the chest strap or grasp both touch-sensitive handlebar grips. When a heartbeat is detected, the Heart Rate display shows your heart rate and the SmartRate LED pulses and indicates your target zone.

## Guidelines

Read the following before using the heart rate feature.

- Consult your physician before engaging in any vigorous exercise. Do not use the heart rate features until authorized by your physician.
- Know your heart rate (pulse) and your physician-recommended heart rate target zone. Individual heart rates vary according to several physiological factors and may not correspond directly with Diagram 3.

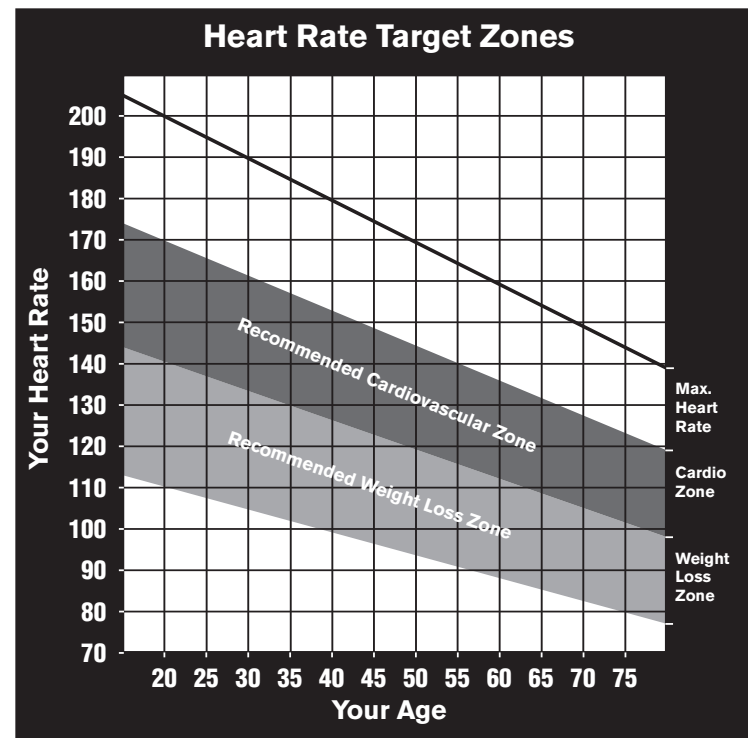

**Diagram 3: Heart rate target zones**

- The calculation used for the heart rate target zone is:  
Low range:  $(220 \text{ minus your age}) \text{ multiplied by } 55\%$   
High range:  $(220 \text{ minus your age}) \text{ multiplied by } 85\%$

- After you put on the chest strap, face the display console for a minimum of 15 seconds. This allows the receiver in the console to recognize the signal from the chest strap. If three dashes (— — —) appear on the display, the cycle is detecting a signal, but has not yet determined your heart rate. Make sure the chest strap is positioned properly around your chest and against your skin.
  - If you prefer to use the hand-held heart rate feature, grasp both touch-sensitive handlebar grips and wait five to ten seconds. Make sure both hands are moist (not dry). When a signal is detected, **Hr** flashes in the Heart Rate display. Within a few seconds, your heart rate appears.
- Important:** While exercising, do not wear a chest strap and grasp the touch-sensitive handlebar grips at the same time. Using both features may cause erratic heart rate readings.
- Always face forward on the cycle and use the handlebars for balance.

## Using the Heart Rate Touch-Sensitive Grips

While exercising, you must grasp both touch-sensitive handlebar grips for a minimum of five to ten seconds to transmit your heart rate to the display. Refer to Diagram 4.

C846i Recumbent

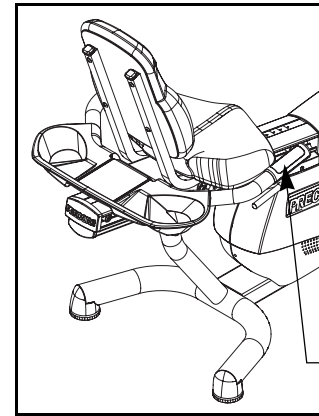

C846i Upright

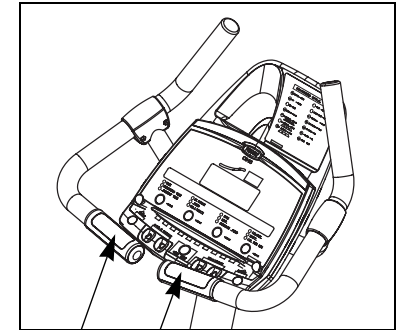

Touch-sensitive  
handlebar grips

### Diagram 4: Touch-sensitive handlebar grips

Usually, the concentration of salts in a person's perspiration provides enough conductivity to transmit a signal to the receiver inside the display console. However, some people, because of body chemistry or erratic heart beats, cannot use the hand-held heart rate feature on the cycle. A chest strap may provide better results.



## Using SmartRate

The SmartRate feature helps you monitor and maintain your heart rate in the target zone best suited to your specific needs. All 15 LEDs may light during a workout. When the cycle detects a heart rate, a single LED blinks and indicates the zone that your heart rate is in, either weight loss or cardiovascular.

The 15 LEDs in the SmartRate display are color-coded. A pulsating red LED indicates you are outside the recommended heart rate target zone. Yellow LEDs indicate when you are exercising within the weight loss zone. Green LEDs indicate when you are exercising within the cardiovascular zone.

Refer to Table 1 to see the relationship between the pulsating LED and your target heart rate.

The SmartRate indicator lights do not appear when:

- You press QUICKSTART at the Precor banner.
- You bypass the AGE prompt.
- You do not wear or improperly position the chest strap. Or, you fail to grasp both touch-sensitive handlebar grips for five to ten seconds.

**Table 1. Heart rate target zones and SmartRate LEDs**

<i>Heart Rate Zone Percent</i>	<i>LED Lit</i>	<i>LED Blinking</i>
Below 50	First	Red
50 to 54	Second	Red
55 to 57	Third	Yellow
58 to 60	Fourth	Yellow
61 to 63	Fifth	Yellow
64 to 66	Sixth	Yellow
67 to 69	Seventh	Yellow
70 to 71	Eighth	Green
72 to 74	Ninth	Green
75 to 76	Tenth	Green
77 to 79	Eleventh	Green
80 to 81	Twelfth	Green
82 to 84	Thirteenth	Green
85 to 87	Fourteenth	Red
Above 87	Fifteenth	Red

**CAUTION: Your heart rate should never exceed 85% of your maximum aerobic heart rate. If it does, immediately reduce your pedaling speed (RPM) or the resistance to return your heart rate to your physician-recommended target zone.**

## Exercise to Your Target Heart Rate

The cycle includes a heart rate receiver so you can monitor your heart rate while exercising. If you wear a chest strap or grasp both touch-sensitive handlebar grips, your heart rate appears on the display.

The Precor website ([www.precor.com](http://www.precor.com)) has several suggestions for workouts with varying levels of intensity. It provides many workout details that include the appropriate target heart rate.

The cycle includes a program that lets you exercise based on a specified heart rate. You set your target heart rate at the beginning. As you exercise, the Heart Rate Program monitors your heart rate and automatically maintains it within a few beats per minutes (bpm) of your selected target. To use this program, select 9 HEART RATE CONTROL. For more information, refer to *Programs*.

## Heart Rate Analysis

Every time you complete a program using the chest strap or touch-sensitive grips, the cycle provides a heart rate analysis after the workout summary.

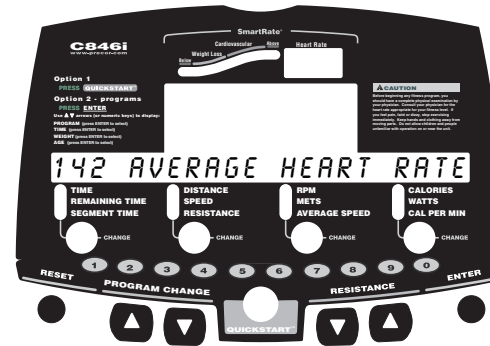

Your average heart rate appears followed by the maximum heart rate achieved during your workout. A third display, indicates the amount of time your heart rate remained between the target zones shown.

The heart rate analysis is based on how often your heart rate signal is received while exercising. If you use the chest strap, the average heart rate will be more accurate than if you occasionally grasp the touch-sensitive grips.

**Note:** The Fitness Test does not provide a heart rate analysis display. It is replaced by a fitness score. Refer to *14 Fitness Test* in the *Programs* section.

# Display Console

**Center display:** Initially shows the Precor banner. It changes to the program profile. A blinking column in the profile indicates your position.

**SmartRate display:** LEDs light in this column when the SmartRate feature is activated. Follow the LEDs to monitor your heart rate and maintain it in your target zone.

**Heart Rate display:** If a heart rate is detected, this area displays your heart rate.

**Lower display:** When the program profile appears in the center display, the program name and number appear in the lower display. While you exercise, four sets of numbers show information about your session. Use the CHANGE keys to choose what information to display.

**CHANGE keys:** Each key lets you move through the information in each column, choosing what you want to display during your session. When you begin a program, use these keys to change specific information.

**LEDs:** Light and clarify what workout statistics appear on the display.

**Number keys:** During a workout, use the number keys to select the resistance level, then press the corresponding arrow key to initiate the change. When you begin a program, you can use the number keys to specify workout selections.

**Keypad:** Use the keypad to:

- Control your workout session
- Answer prompts prior to starting a program
- Change the program
- Prematurely end a program
- Adjust the resistance

**QUICKSTART:** Press QUICKSTART to begin your workout immediately. It lets you bypass the setup prompts.

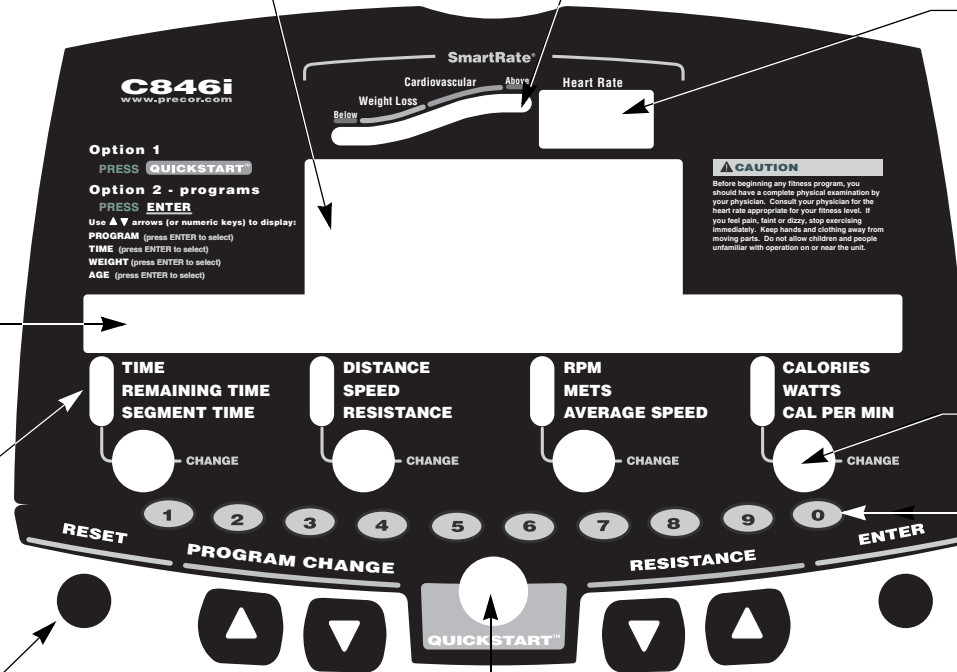

## More Information about the Center Display

During a workout, the program profile on the cycle is affected by the RESISTANCE arrow keys. The profile raises or lowers according to which arrow key (▼ or ▲) is pressed.

In most programs, the resistance setting affects the column height in the program profile as shown in Diagram 5.

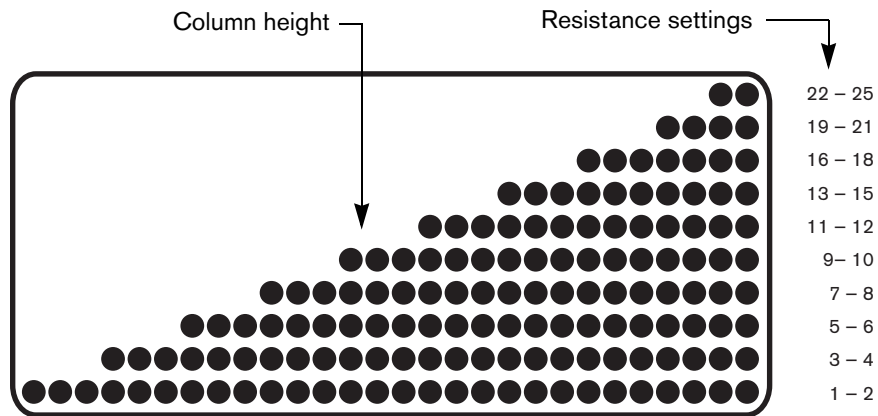

**Diagram 5: Column height in the program profile**

In the Heart Rate Control Program, the RESISTANCE arrow keys affect the target heart rate. Refer to *Programs*.

## More Information about the Lower Display

The lower display provides information about your workout session. A number appears over each column of information. You can choose the type of information displayed using the CHANGE key below each column. More information about this display is provided below.

### Column 1: TIME, REMAINING TIME, and SEGMENT TIME

**TIME**—displays workout time in minutes and seconds; however, when you exceed 60 minutes during a single workout, the TIME display converts to hours and minutes. For programs with a workout time limit, the TIME display shows the amount of time remaining. For programs without a workout time limit, the TIME display indicates the amount of time you have been exercising.

**Note:** The club can place limits on workout time.

**REMAINING TIME**—indicates the amount of time, in minutes and seconds (MM:SS), which remains in the program. In a cool-down period, the REMAINING TIME resets to the club limit and begins counting down from there.

**Note:** If the REMAINING TIME display does not appear, it is likely that the club has customized settings. Check with the club manager.

**SEGMENT TIME**—indicates the amount of time, in minutes and seconds (MM:SS), that remains in the highlighted column before the next column begins blinking in the profile.

## **Column 2: DISTANCE, SPEED, and RESISTANCE**

**DISTANCE**—shows the linear distance in miles or kilometers. The distance is calculated based on your current pedaling speed (RPM) and resistance setting.

**SPEED**—shows the linear distance in miles or kilometers. The distance is calculated based on your current pedaling speed (RPM) and resistance setting.

**RESISTANCE**—shows the linear distance in miles or kilometers. The distance is calculated based on your current pedaling speed (RPM) and resistance setting.

## **Column 3: RPM, MET, and AVERAGE SPEED**

**RPM**—indicates the number of pedal revolutions completed per minute. The value can range between 20 and 150.

**METS**—shows the metabolic units associated with your workout.

**AVERAGE SPEED**—relates to the total workout time divided by the total accumulated distance. The displayed value provides an estimate of the average speed you would be traveling if you were not on a stationary bike.

## **Column 4: CALORIES, WATTS, and CAL PER MIN**

**CALORIES**—displays the estimated cumulative number of calories burned. The calorie calculation is derived from the pedaling speed and your weight. An accurate weight entry results in a more accurate calorie count. When using QUICKSTART and a weight has not been specified, the default weight is 150 pounds (68 kilograms).

**WATTS**—displays the current mechanical energy generated by the unit.

**CAL PER MIN**—displays the approximate number of calories burned per minute.

## Keypad

Use the keypad to enter your workout session selections. Keys on the keypad respond to the slightest touch. Use gentle pressure on the keys as you exercise.

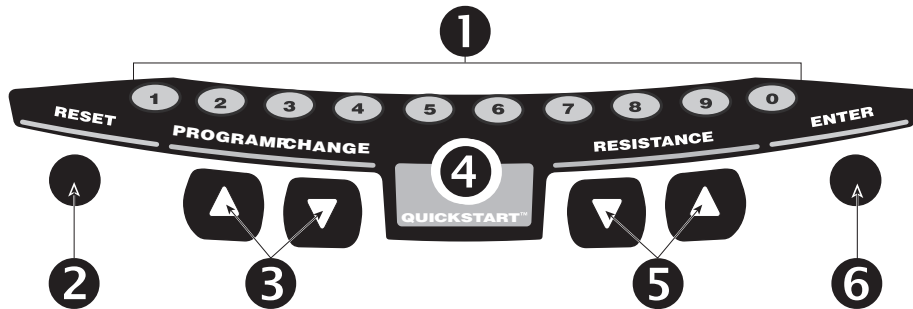

- 1 NUMBER KEYS (1–9 and 0):** You can use the number keys to change workout session information such as program selection, workout time, weight, and age.

During a workout, you can use the number keys to designate the resistance or target settings and, within three seconds, press the corresponding arrow key to initiate the change.

- 2 RESET:** During your exercise session or from pause mode, press the RESET key to display a WORKOUT SUMMARY. Press RESET again to return to the Precor banner.

**Important:** The optional power adapter must be connected before you can pause during your exercise session for more than 30 seconds.

- 3 PROGRAM CHANGE ▲▼:** You can use the PROGRAM CHANGE ▲▼ keys to switch to a different program during an exercise session. Tap a PROGRAM CHANGE arrow key to view the current program. Press a PROGRAM CHANGE arrow key for a few seconds to select a new program number and the profile changes accordingly. You can also choose a new program using the number keys. For more information, refer to *Changing the Program during an Exercise Session*.

**Important:** You cannot make a mid-session change to or from the Weight Loss or Fitness Test programs using the PROGRAM CHANGE arrow keys. The opposite is also true. The PROGRAM CHANGE arrow keys are disabled when you use the Weight Loss or Fitness Test programs, so you cannot make a mid-session change to another program.

- 4 QUICKSTART:** Press QUICKSTART to bypass the setup prompts and start your workout immediately using the Manual Program. Refer to *Choosing QUICKSTART*.

- 5 RESISTANCE ▼▲:** Press and hold the RESISTANCE arrow keys to increase or decrease the resistance you feel against the pedals. The RESISTANCE ▼▲ keys affect the brake and let you set a resistance between 1 and 25.

- 6 ENTER:** Use the ENTER key to enter responses to workout-specific prompts.

# Workout Options

**CAUTION:** Before beginning any fitness program, see your physician for a complete physical examination. Know your physician-recommended heart rate target zone.

1. Sit on the seat and place your feet inside the pedal straps.

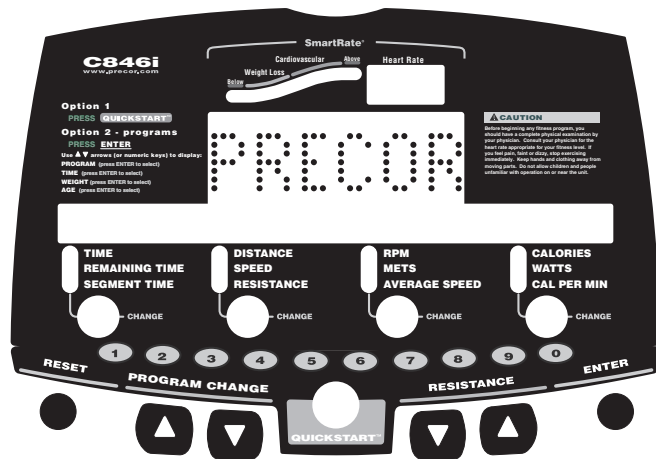

2. When you are comfortably situated, begin pedaling.

3. Select one of the following options:

Option...	Steps...
To start exercising immediately	<ul style="list-style-type: none"> <li>• Use the QUICKSTART key.</li> <li>• Refer to <i>Choosing QUICKSTART</i>.</li> </ul>
To select a program and workout time, and specify your weight and age, and answer other program-specific prompts	<ul style="list-style-type: none"> <li>• Use the ENTER key.</li> <li>• Refer to <i>Selecting a Program</i>.</li> </ul>
To select a different program during an exercise session	<ul style="list-style-type: none"> <li>• Use the PROGRAM CHANGE arrow keys.</li> <li>• Refer to <i>Changing the Program during an Exercise Session</i>.</li> </ul>

## Choosing QUICKSTART

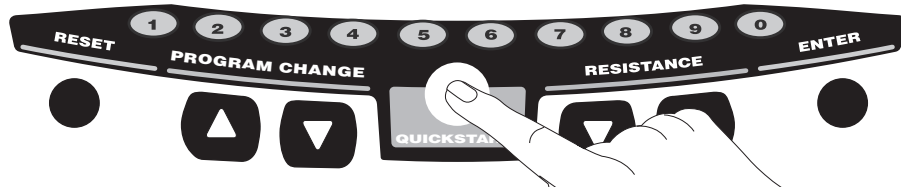

1. Press QUICKSTART at the Precor banner to bypass the setup prompts and access the Manual Program.

QUICKSTART applies the following defaults:

Prompts	Default Value
Program	Manual
Time	Club setting or 30 minutes
Weight	150 lb (68 kg)
Age	0

To use the SmartRate feature, you need to specify your age. In this case, press ENTER and follow the setup prompts to enter your age. Press QUICKSTART after your age is displayed.

2. Use the RESISTANCE ▼▲ keys to change the resistance.

**Note:** To select a different program during your exercise session, use the PROGRAM CHANGE ▲▼ keys to select a different program during your exercise session. Refer to *Changing the Program during an Exercise Session*.

## Selecting a Program

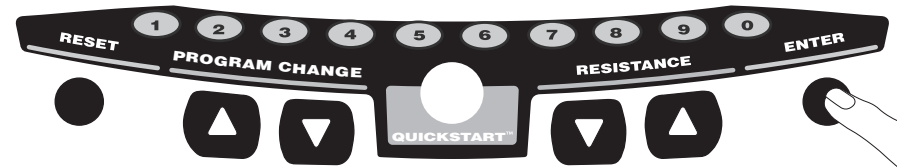

1. At the Precor banner, press ENTER, and then press the arrow keys to cycle through the available programs.

A portion of the program profile appears in the center display. The program number and name appear in the lower display.

2. Select the program you want, and then press ENTER.

**Note:** You can also use the number keys to select a program, choose the program time, and enter your weight, age and other program-specific prompts.

3. A workout time blinks in the lower display. The display indicates the club limit or the default time of 30 minutes. Press the arrow keys to select a workout time (between 1 and 240 minutes) and then press ENTER.

**Note:** If the club allows it, you can select an unlimited workout time by pressing the number 0 and then pressing ENTER.



4. Enter your weight (1–999) and then your age (1–99).  
**Note:** If you select the Watts Control, Distance, or Calories Program, you will be prompted for additional program-specific entries.
5. To change a value that you have already entered, press RESET and reenter the information.  
**Note:** You can press QUICKSTART after any of the prompts (program name, workout time, weight, or age entry). QUICKSTART applies user preferences and uses the club's default settings for any prompts skipped.
6. Use the RESISTANCE ▼▲ keys to change the pedal resistance.

## Changing the Program during an Exercise Session

While exercising or during the cool-down period, you can select a different program (except Weight Loss or Fitness Test) by touching the PROGRAM CHANGE ▲▼ keys. Accumulated workout statistics and workout time are transferred to the new program selection.

**Note:** Continue pedaling and keep the RPM above 20 while you adjust to your new selection.

To select a new program, take the following steps:

1. Press a PROGRAM CHANGE ▲▼ key. The display indicates the program that is currently running. Continue to press either PROGRAM CHANGE ▲ or ▼ key to display a different program.

**Note:** While selecting a new program, your exercise session is momentarily suspended. The LEDs next to the workout statistics are not lit. If QUICKSTART or ENTER are not pressed within five seconds, the cycle resumes your exercise session without making any program changes.

2. Select one of the following options:

<b>Option...</b>	<b>Steps...</b>
To select the displayed program and carry forward all aspects of the previous program (workout time, statistics, weight, age, etc.)	<ul style="list-style-type: none"> <li>• Use the QUICKSTART key.</li> </ul>
To select the displayed program and add additional information by answering program-specific prompts	<ul style="list-style-type: none"> <li>• Use the ENTER key.</li> </ul>

**Note:** When the club time limit is set to expire within one minute, the PROGRAM CHANGE ▲▼ keys are disabled.

## Cooling Down After a Workout

Incorporate a cool-down period into your workout to help lower your heart rate and minimize muscle stiffness or soreness.

When you complete a program with a time limit, you automatically enter a cool-down period. The Manual Program profile appears in the display and resistance reduces by 20%. To change the resistance, press the RESISTANCE arrow keys.

A workout summary appears at the end of the cool-down period. Refer to *Ending a Workout*.

**Important:** *If you specify an unlimited workout time, remember to incorporate a cool-down period at the end of your workout. If you exit a program before completing it, the cool-down period is bypassed.*

To prematurely end the cool-down period, do the following:

1. Continue pedaling.
2. Press RESET to view the WORKOUT SUMMARY.
3. Press RESET again to return to the Precor banner.

## Pausing During a Workout or the Cool-Down Period

If you stop pedaling anytime during your exercise session or during a cool-down period, the cycle begins a 30-second shutdown. You cannot pause beyond the 30-second limit unless the club has the optional power adapter attached to the unit.

When the optional power adapter is attached, you can pause for a set time, usually two minutes. If you do not resume pedaling during that time, the display returns to the banner.

1. To pause, stop pedaling.
2. To resume exercising from pause mode, begin pedaling.

## Ending a Workout

**CAUTION:** Hold on to a stationary handrail when you near the end of a workout.

1. Slow your pedaling speed (RPM) when you complete the cool-down period.
2. To view your workout summary, continue pedaling above 20 RPM.

The **WORKOUT SUMMARY** appears and shows your cumulative workout statistics including warm-up and cool-down periods. Other information including RPM, calories per minute, and watts reset to zero. You can review your workout statistics as long as you continue pedaling.

**Note:** A heart rate analysis appears if you use the touch-sensitive handlebar grips or wear the chest strap during your workout. For more information, refer to *Heart Rate Analysis*.

3. End your workout by pressing the **RESET** key and return to the Precor banner.

**Note:** If the optional power adapter is attached, you do not have to continue pedaling to view your workout statistics. When you complete the cool-down period, the **WORKOUT SUMMARY** appears. Press **RESET** to return to the Precor banner.

# Programs



**Diagram 6: C846i program label**

This section describes the programs printed on the C846i display console.

## Choosing a Program

Choosing a program depends on your goals. If you are a beginner or returning to regular exercise, you can start a cardio-conditioning program to slowly return your body to a comfortable level of exercise. If you have been exercising and feel that you have an intermediate or advanced fitness level, you probably have established goals. The Precor website ([www.precor.com](http://www.precor.com)) can give you many ideas about fitness workouts and advice from the experts.

Several workout choices on the cycle are preprogrammed with recommendations for the resistance and alternating rest or work intervals. You always have the option to override the suggested levels with the exception of the Fitness Test and the Heart Rate Control Program.

If your level of exertion becomes too great, reduce your pedaling speed (RPM) or use the arrow keys to override the resistance in each upcoming column in the program profile. If you use the RESISTANCE arrow keys, the profile changes accordingly.

## Program Tips

- While exercising, your pedaling speed (RPM) needs to remain above 20 RPM. Dropping below 20 RPM causes the cycle to shut down to conserve battery power. The cycle displays a 30-second countdown before it shuts off. If you pedal above 20 RMP during the countdown period, you can resume exercising where you left off.
- A blinking column tracks the progress that you make during a program.
- The club can set limits for workout, pause, and cool-down times.

## 1 Manual Program

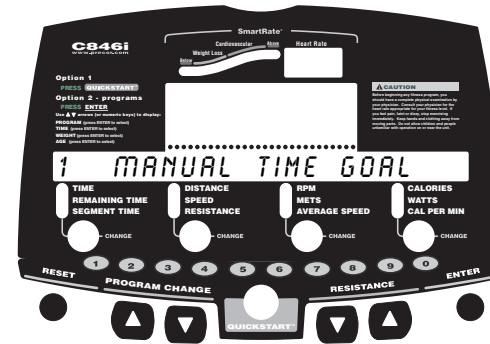

You control the resistance settings when you use the Manual Program. The profile begins as a flat line. Use the RESISTANCE arrow keys to select the resistance. The program profile reflects changes. The blinking column indicates your position in the program.

If you press QUICKSTART at the banner and access the Manual Program, the workout time is set at the club limit or 30 minutes (whichever time is less).

To use the SmartRate feature, you need to specify your age. Refer to *Selecting a Program*.

## 2 Cross Country Program

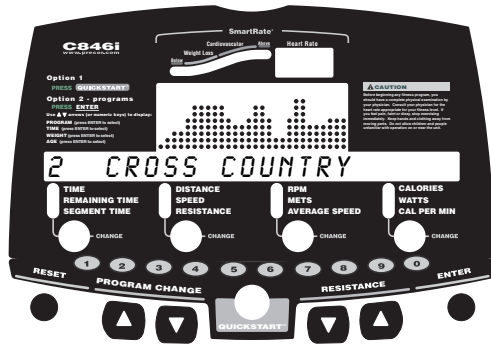

The Cross Country Program is a variable resistance program. It is similar to the Hill Program, but provides a different preprogrammed resistance profile. To override the resistance settings for each column, press the RESISTANCE arrow keys. The changes raise or lower the columns on the remaining portion of the program profile.

## 3 Hill Program

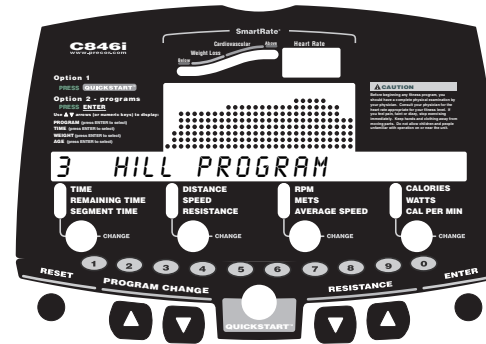

The Hill Program is a variable resistance program that works the leg muscle groups. The resistance in the Hill Program is preprogrammed. To override the resistance settings for each column, press the RESISTANCE arrow keys. The changes raise or lower the columns on the remaining portion of the program profile.

## 4 Random Program

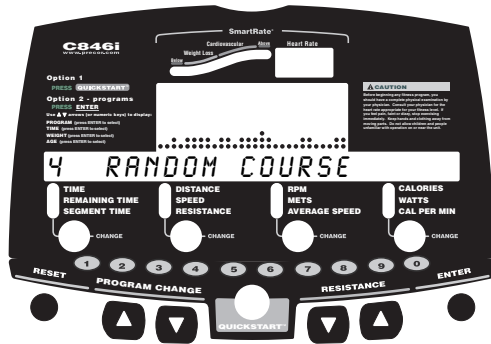

Every time the Random Program is selected, a different program profile appears. The columns that appear in the program profile show the preprogrammed resistance. To override the settings for each column, press the RESISTANCE arrow keys. The changes raise or lower the columns on the remaining portion of the program profile.

The resistance is preset to 1 for the first column. The maximum resistance change allowed between columns is plus or minus 4.

## Interval Programs 5, 6, and 7

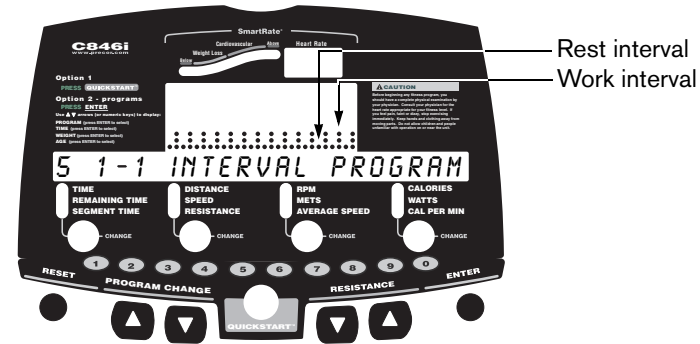

The Interval Programs are among the best for conditioning your cardiovascular system. Each program raises and lowers your level of exertion repeatedly for a specified period of time.

When you begin the program, the resistance for the rest and work intervals is preprogrammed. The settings are repeated throughout the program unless you change them.

Three programs let you choose the rest and work intervals according to your training regimen.

<i>Interval Program</i>	<i>Rest Duration</i>	<i>Work Duration</i>
5 1-1	1 minute	1 minute
6 1-2	1 minute	2 minutes
7 1-3	1 minute	3 minutes

To change the settings, press the appropriate arrow key and continue. The changes are applied to the remaining intervals. The display lets you know when the resistance is about to change, and indicates the level of the next interval.

## 8 Watts Control Program

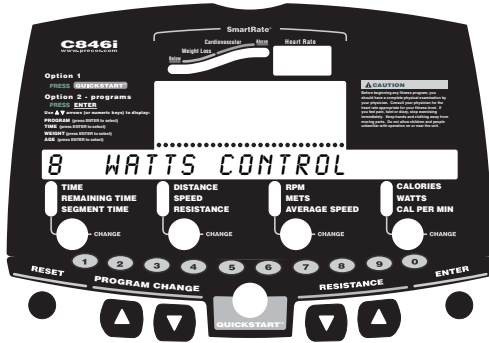

The Watts Control Program automatically regulates the resistance settings to keep the level of energy expenditure constant regardless of the pedaling speed.

**Important:** In the Watts Control Program the RESISTANCE ▼▲ keys affect the target watt setting.

When you begin the program, the initial resistance is 1 and the initial target is 50 watts.

Use the RESISTANCE arrow keys to change the target setting in 10-watt increments. Available target settings range from 30 to 400 watts.

The number keys may also be used to set the desired target. Refer to the *Display Console* section.

## 9 Heart Rate Control Program

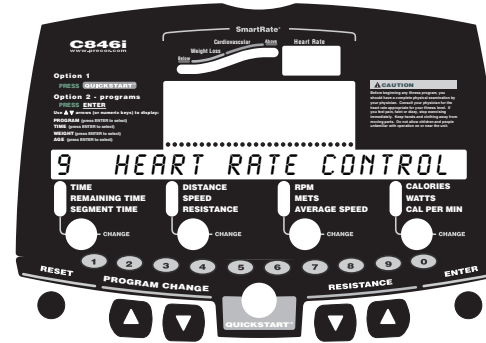

The Heart Rate Control Program lets you set a target for your heart rate. The program adjusts the resistance to maintain your heart rate within two beats per minute of the target heart rate while you exercise. To use this program, you must wear the chest strap so the program can monitor your heart rate throughout the session.

During your workout, the number that represents your heart rate appears in the Heart Rate display.

For information about understanding your target heart rate, refer to *Heart Rate Features*.

**Important:** Consult your physician to determine the appropriate target heart rate for your age and fitness level. If your physician recommends a different target heart rate than the one that appears on the display, use the appropriate arrow keys to change the target heart rate once you finish the warm-up period. Do not exercise over the recommended range.



## Warm-Up Period

The cycle provides a 3-minute warm-up period. During this time, you may change the resistance.

**Note:** If your heart rate moves into the target heart rate zone  $[(220 \text{ minus age}) \times 70\%]$  during the 3-minute warm-up period, the warm-up period ends and the Heart Rate Control Program begins.

## Using the Heart Rate Control Program

When you access the Heart Rate Control Program, the following occurs:

- The cycle automatically adjusts the resistance to keep your heart rate at the selected target. Pressing the RESISTANCE arrow keys no longer affects the resistance, but does change the target heart rate. Check the SmartRate display to see if you are maintaining your preferred zone (weight loss or cardiovascular). Check the Heart Rate display to determine your actual heart rate.
- **Important:** Automatic adjustments to the resistance cannot take place if you drop below 20 revolutions per minute (RPM).
- You can change the target heart rate, but doing so affects the unit's ability to maintain your target heart rate in the preferred zone. It takes time for the cycle to readjust the resistance so that your heart rate remains on target.
- When you complete the program, remember to add a cool-down period.

**Note:** If you are having difficulty with the heart rate features, talk to your club representative.

## 10 Weight Loss Program

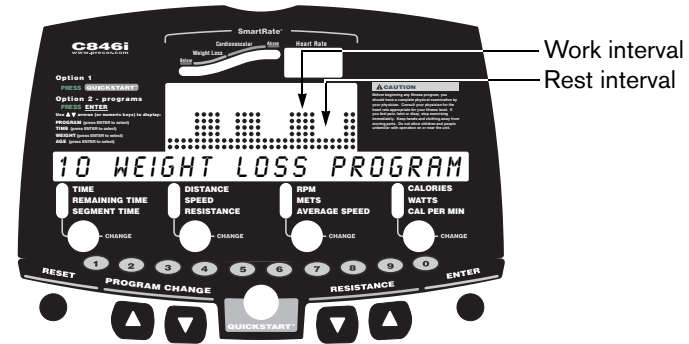

With the Weight Loss Program, the workout time is fixed at 28 minutes and consists of seven 4-minute intervals. You are not prompted for a workout time. Use the arrow keys to change the resistance for the rest or work interval. When you make changes, the program repeats the settings for the remaining intervals.

The display lets you know when the resistance levels are about to change.

For the ideal weight loss range, your heart rate should be between 55% and 70% of your maximum aerobic heart rate. If you wear the chest strap or grasp both touch-sensitive grips, you can use SmartRate as a visual cue.

- Set a comfortable pedaling speed (RPM) and then adjust the resistance.
- Maintain a level of exertion so that the first yellow LED blinks in the SmartRate display during rest intervals.
- During the work intervals, increase your level of exertion so that the first green LED blinks.

For more information about the SmartRate display, refer to *Using SmartRate*.

## 11 Custom Resistance Program

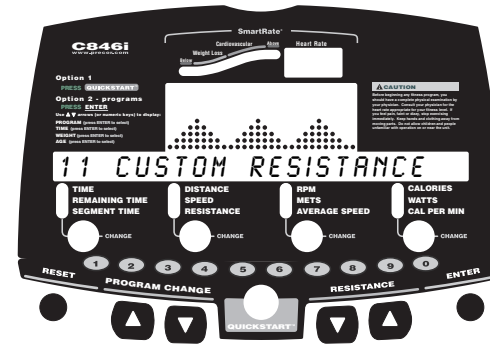

A club has the option to create a profile customized for its patrons. The Custom Resistance Program provides variable preprogrammed resistances. Similar to other programs on the cycle that have preprogrammed resistance, you can override the settings using the RESISTANCE arrow keys. The changes are applied to the remaining profile.

To learn how to create this custom program, refer to the *Product Owner's Manual*.

## 12 Distance Program

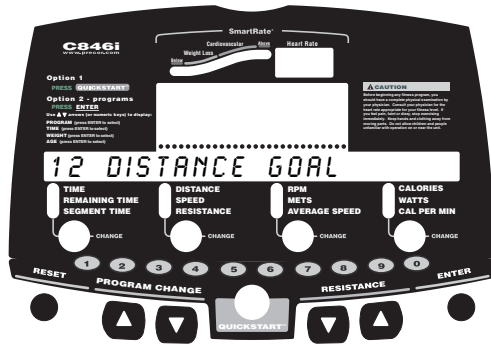

This program lets you designate a fixed distance. When you reach your goal, the program ends and the automatic cool-down period begins.

After selecting the Distance Program, specify your distance goal at the blinking prompt. Acceptable entries are from 0.1 to 50 (miles or kilometers). Use the arrow keys to change the value, and then press ENTER to begin. Refer to *Workout Options*.

**Note:** The club time limit applies to this program and may affect your ability to reach the set goal. Contact your facility manager if you encounter problems.

## 13 Calories Program

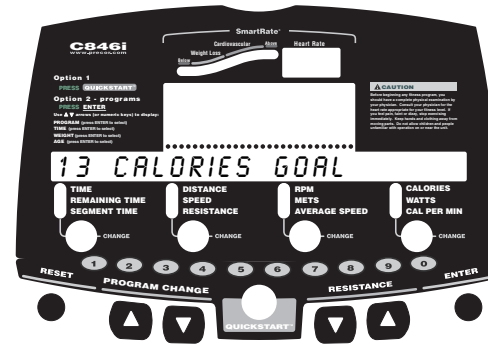

This program lets you designate a fixed calorie goal. When you reach your goal, the program ends and the automatic cool-down period begins.

After selecting the Calories Program, specify your calorie goal at the blinking prompt. Acceptable entries range from 1 to 5000 calories.

Use the arrow keys to change the value, and then press ENTER to begin. Refer to *Workout Options*.

**Note:** The club time limit applies to this program and may affect your ability to reach the set goal. Contact your facility manager if you encounter problems.

## 14 Fitness Test

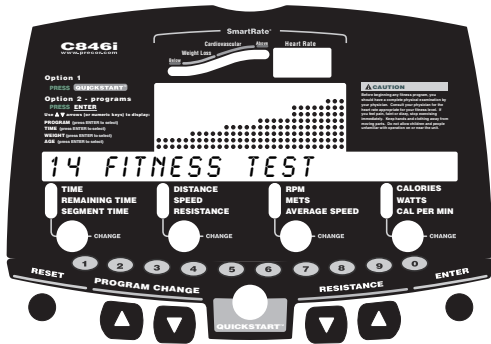

The Fitness Test monitors your heart rate and calculates a fitness score based on your average heart rate during specific test stages. When the test is completed, the display provides a fitness score and fitness category.

The test results can help you gauge the effectiveness of your current exercise routine and tailor it to meet your fitness goals.

### Guidelines

Before selecting the Fitness Test, read the following guidelines:

- Sit and rest for at least five minutes prior to taking the test to bring your heart rate to a resting state.
- The fitness score is affected by your weight, age, and gender. You must enter this data during the setup phase.

- For accurate heart rate readings, you must wear the chest strap throughout the test. The test acquires your heart rate during a test stage. If the heart rate reception is erratic, incorrect readings can occur and affect the accuracy of the overall fitness score.
- When the first minute of the warm-up period elapses, the arrow keys are disabled.

### Warm-Up Period

The cycle provides a 3-minute warm-up period before beginning the Fitness Test. During the warm-up period, the resistance is fixed and cannot be adjusted. Continue pedaling at a constant pace. The Fitness Test commences at the end of the warm-up period.

**Important:** *If a message appears stating that your heart rate is too high, the test ends and the automatic cool-down period begins. Complete the cool-down period and retake the Fitness Test later.*

## Using the Fitness Test

Let the program adjust the resistance for you.

**CAUTION:** If you need to stop to regain control or reduce your heart rate, please do so. You can retake the Fitness Test later.

## Completing the Fitness Test

When you finish the Fitness Test, the resistance is reduced. An automatic cool-down period is provided after the test to help return your heart rate to a normal, restful state.

The Fitness Test automatically ends if one of the following occurs:

- You stop pedaling.
- Your pedaling speed (RPM) drops below 20.
- Your heart rate increases above the maximum allowable heart rate for that stage.
- Your heart rate cannot be detected.
- You press RESET.
- You complete the test.

## Fitness Test Scores

When you complete the Fitness Test, your fitness score and cardiovascular fitness level appear on the display.

Tables 2 and 3 show the desired range in fitness levels depending on your age and gender. More information is available at the Precor website ([www.precor.com](http://www.precor.com)).

**Table 2. Cardiorespiratory fitness score category—females\***

Age in Years	Fitness Category		
	Low Fitness	Medium Fitness	High Fitness
20–39	28 (or below)	28–33	33 (or above)
40–49	26 (or below)	26–31	31 (or above)
50–59	24 (or below)	24–28	28 (or above)
60 and over	22 (or below)	22–26	26 (or above)

**Table 3. Cardiorespiratory fitness score category—males\***

Age in Years	Fitness Category		
	Low Fitness	Medium Fitness	High Fitness
20–39	35 (or below)	35–42	42 (or above)
40–49	32 (or below)	32–39	39 (or above)
50–59	29 (or below)	29–36	36 (or above)
60 and over	24 (or below)	24–31	31 (or above)

\* The test and analysis algorithm were developed by Dr. Neil Gordon of Cooper Clinic.

*Notes:*





Precor Incorporated  
20031 142nd Ave NE  
P.O. Box 7202  
Woodinville, WA USA 98072-4002

Precor, C, CrossRamp, EFX, M, Move Beyond, and SmartRate are registered trademarks of Precor Incorporated. Crosstrainer, QuickStart, and StretchTrainer are trademarks of Precor Incorporated.  
Copyright 2005 Precor Incorporated.  
Specifications subject to change without notice.  
[www.precor.com](http://www.precor.com)

**NOTICE:**

Precor is widely recognized for its innovative, award winning designs of exercise equipment. Precor aggressively seeks U.S. and foreign patents for both the mechanical construction and the visual aspects of its product design. Any party contemplating the use of Precor's product designs is hereby forewarned that Precor considers the unauthorized appropriation of its proprietary rights to be a very serious matter. Precor will vigorously pursue all unauthorized appropriation of its proprietary rights.



C846i URM 48819-101, en  
15 July 2005



# Assembly Guide



C846i

**PRECOR**<sup>®</sup>  
USA  
move beyond<sup>®</sup>

C842i

C846i

Commercial Recumbent Cycle



Thank you for choosing Precor. For proper installation, please read this guide thoroughly and follow the assembly instructions. If you do not assemble the C846i/C842i Recumbent Cycle according to these guidelines, you could void the Precor Limited Warranty.

## Obtaining Service

You should not attempt to service the recumbent cycle except for maintenance tasks as described in the *Product Owner's Manual*. If any items are missing, contact your dealer. Should you need more information regarding customer support numbers or a list of Precor authorized service centers, visit the Precor website at [www.precor.com/contact](http://www.precor.com/contact).

## Unpacking the Equipment

The unit is shipped on one pallet. Ask for help from two or more people to unpack and assemble the recumbent cycle.

## Required Tools



- Wire tie cutter
- One  $\frac{3}{4}$ -inch combination wrench (open-end or box)

## Installation Requirements

Follow these installation requirements when assembling the unit:

- **Assemble the unit near the location where you plan to use it.**
- **Provide ample space around the unit.**  
Open space around the unit allows for easier access.
- **Set up the recumbent cycle on a solid, flat surface.**  
A smooth, flat surface under the unit helps keep it level. A level unit has fewer malfunctions.
- **Open the box and assemble the components in the sequence presented in this guide.**
- **Leave room for adjustments.**  
Tighten fasteners (bolts, nuts, and screws) so the unit is stable, but leave room for adjustments. Do not fully tighten fasteners until instructed to do so.
- **If you plan to move the unit, obtain help and use a hand truck.** Do not grasp any plastic parts while lifting or moving the unit. The plastic parts are not capable of supporting the weight of the unit and they may break.

## Hardware Kit (not to scale)

Fasteners		Quantity
	(A) Hex head cap screw (5-inch)	2
	(B) Washer (1/2-inch)	2
	(C) Buttonhead screw (1 3/4-inch)	4

2 – Rubber bib (D)

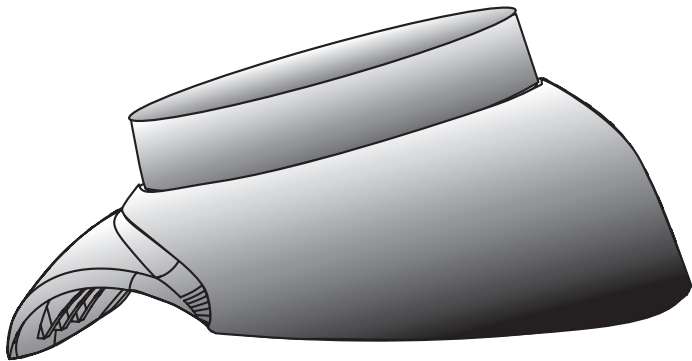

1 – 3/16-inch hex key (E)



# Assembly Steps

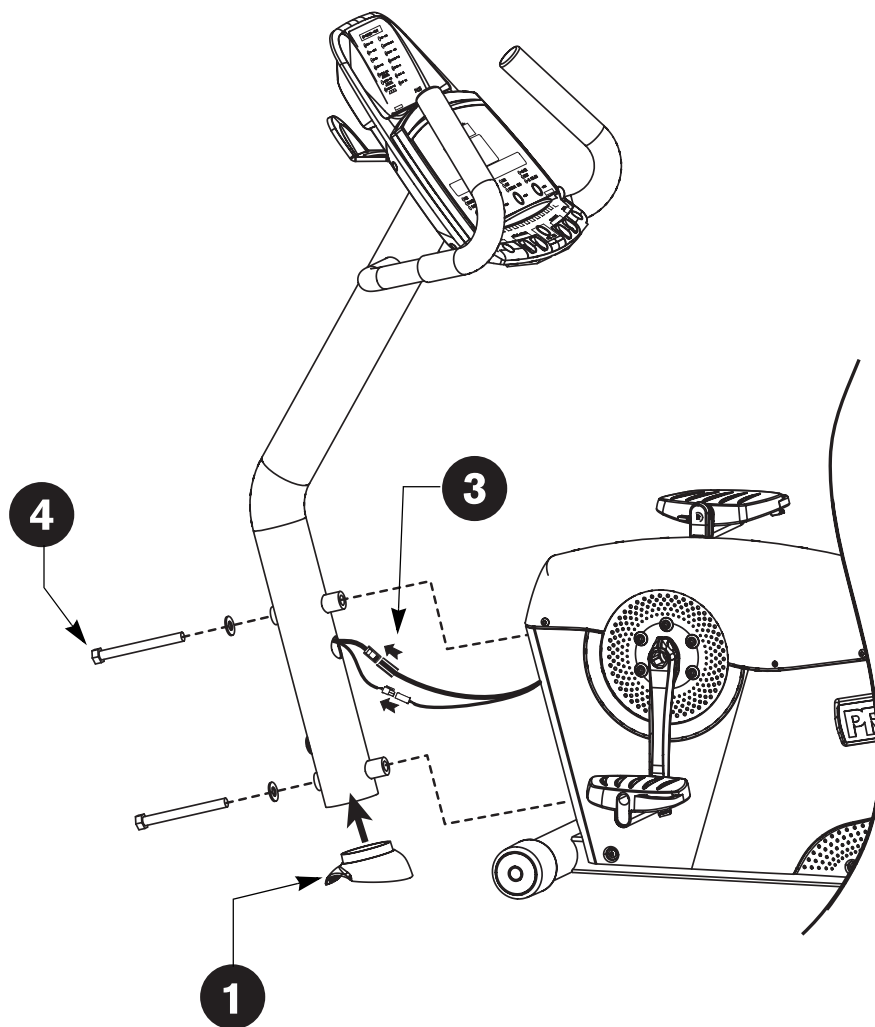

- 1 Position the rubber bib so the flared side faces the floor (as shown in the illustration) and slide it into the base of the upright support.
- 2 Place the upright support on the base crossbar so that the lip of the rubber bib rests on the crossbar and is parallel to the floor.
- 3 Have your assistant hold the upright support while you connect the two cables. Place excess cable inside the base assembly.

**Note:** The C842i has only one cable connection.

**Important:** Do not stretch, crimp, or damage the cables. Cables damaged by improper installation will not be covered by the Precor Limited Warranty.

**CAUTION:** Before tightening the screws, make sure the cables are not in danger of being crimped or pinched.

- 4 Secure the upright support to the base assembly using two hex head cap screws (A) and two washers (B). Alternately tighten each screw using a  $\frac{3}{4}$ -inch box-end or crescent wrench. Check the upright support to make sure it is securely fastened.

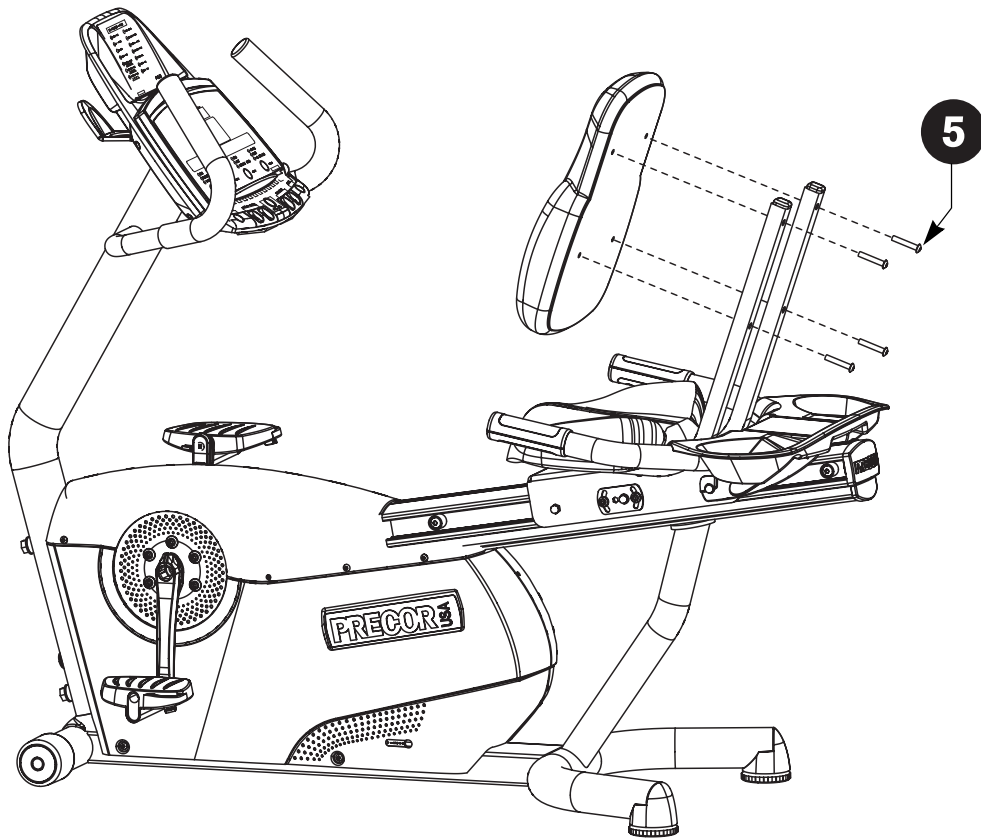

- 5** Rest the seat pad against the seat frame posts. Insert the four buttonhead screws (C) and finger tighten.

**CAUTION: It is critical that you hand thread the four buttonhead screws before alternately tightening them with the hex key (E). The nut inserts on the back of the seat pad can be easily stripped by improper assembly, which is not covered by the Precor Limited Warranty.**

- 6** When the four buttonhead screws (C) are properly threaded, alternately wrench tighten each screw using the hex key (E).
- 7** Sit on the seat to adjust it. Pull up on the seat adjustment handle and use your legs to slide the seat along the center post.

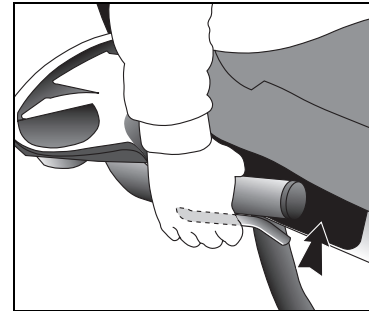

**Note:** If the seat rocks from side to side, you will need to realign the center wheel that runs inside the center post. Refer to the instructions in the *Product Owner's Manual*.

**8**

Level the recumbent cycle. Before allowing users on the recumbent cycle, make sure it does not wobble from side to side.

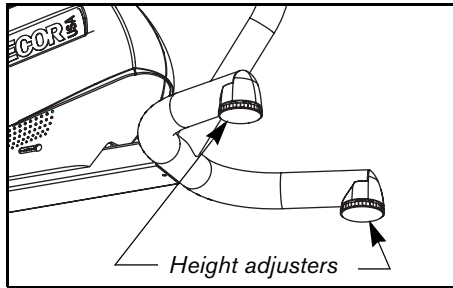

To remove any side-to-side movement, ask your assistant to tip the unit on its side so that you can locate the two height adjusters on the rear crossbar.

Turn the height adjusters until the unit does not wobble or rock from side to side.

**Important:** *If the unit is placed on a slightly uneven surface, rotating the height adjusters can help, but will not compensate for extremely uneven surfaces.*

When you are finished making adjustments, ask your assistant to gently lower the unit to the floor.

**9**

Verify that the C846i heart rate display is operational.

1. Sit on the cycle. When you are comfortably situated, begin pedaling. Pedaling above 20 revolutions per minute (RPM) must be maintained for several seconds.
2. Grasp both touch-sensitive grips on the seat handlebars.
3. Look at the Heart Rate display. The letters **Hr** should be blinking. After a few seconds, a number appears indicating your heart rate.

**Note:** If the display remains blank, refer to the *Product Owner's Manual* for troubleshooting tips. Instructions regarding the chest strap are also found in the *Product Owner's Manual*.

**PRECOR**<sup>®</sup>USA  
move beyond<sup>®</sup>

Precor Incorporated  
20031 142nd Avenue NE  
P.O. Box 7202  
Woodinville, WA USA 98072-4002



©2005 Precor Incorporated  
[www.precor.com](http://www.precor.com)  
C846i/C842i Recumbent AG 48578-101, en  
15 July 2005